

W.H.PERRON N 2025





Purchase by catalog only



FLOWER SEED :

DETAILED DESCRIPTION OF THE PRODUCTS

Common name Botanical name

CONEFLOWER - Echinacea purpurea

20-22 10-14

EXPOSURE

These symbols indicate that the variety will grow well with this following exposure

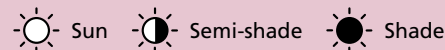

Name of the series and description

PollyNation series

An Echinacea series from seed that will bloom the first year. This early series has large and vivid colour flowers. The plant is well branched, perfect for patio and garden containers. Excellent tolerance to heat and drought. Attracts bees and a wide range of insects.

63-7352-010 PollyNation Yellow

This variety has large early flowers of a bright yellow.

63-7354-010 PollyNation Orange Red

This variety has large early flowers of a bright red orange.

63-7353-010 PollyNation Golden Summer Mix

Mix of Magenta, Orange Red, White, and Yellow.

Hardiness zone: 4 Height (cm): 60-70

Spreading (cm): 30-40

Product number, of variety and description

1 pkg 15 s/p 10.09 \$

1 package of approximately 15 seeds

Price

Weekly maturity from sowing to flowering.

Germination temperature in Celsius.

Number of days of germination.

Melliferous and nectariferous flowers

Cut flowers

F1 The "Hybrid F1" (or generation 1) mention in the name of certain seeds indicates that they are issued from a cross between two (2) plants of pure or stable lines, having coveted characteristics. The hybrid "F1" has a superior quality, called "hybrid vigour" which is the ability to grow faster and more vigorously, thus offering a higher yield than either of its parents. Hybrid seeds can improve flavour, offer greater resistance to disease and insects and cold and heat. This way, you can ensure that your garden has a good chance of success.

VEGETABLES SEEDS

You will notice that all maturities and types of seeds are clearly identified, see legend below.

FORMULATION

Organic seed

Organic exclusive seed

Untreated seed

Untreated exclusive seed

Treated seed

Treated exclusive seed



Coated seed : consists of a uniform, colored clay coating that facilitates seed handling. Sometimes, it may contain a fungicide to promote germination.

Encrusted seed : seed that is coated, colored, with a smaller quantity of material than the coated seed, so that it retains its initial shape.

GMO : Genetically modified organisms*

* To the best of our knowledge, no vegetable seeds sold in this catalogue have been genetically modified.



To meet our clients increasing demands, W.H. Perron is proud to offer a larger variety of certified organic seeds. Just look for the **ORGANIC** symbol.



Organic seeds are Ecocert Canada certified since 2008.

MATURITY

Relative maturity after transplantation

Relative maturity after sowing

2025 NOVELTIES – VEGETABLES



Broccoli Purple Magic F1

Introducing an AAS winner Purple Magic, the first purple stem, purple-headed broccoli in the world. The large, dome-shaped heads weigh in at about ½ a kilo each. Purple Magic is very high in anthocyanin (a plant-based chemical called a flavonoid) and nutritious, as well as being sweeter than green broccoli. The plants grow well in all regions and mature about 90 days harvest from transplant.

Untreated seeds.

Harvest season: Spring, Fall

Maturity (days) T : 90

Code	Maturity (days) S	Seeds / pkg	Price
65-1490-01N	90	75	7,89 \$



White Romanesco Cauliflower Whitaker F1

Similar to traditional green types of Romanesco except in colour, Whitaker shows perfect white spiralled curds. Recommended for summer and fall harvest, Whitaker has a large, sturdy plant. Excellent sold alone or with Veronica. NOTE: under fertilization and/or drought stress, heads may show a slight green tinge.

Treated seeds.

Harvest season: Summer, Fall

Maturity (days) T: 80

Code	Maturity (days) S	Seeds / pkg	Price
65-3880-010	80	20	7,89 \$



Cauliflower Flamenco White F1

Flamenco is a great variety for late summer and fall production. It has a good heat tolerance, and the outer frame leaves are quite long and erect for added shading from the sun. High, bright white heads with dense curds. Mild, sweet flavour that makes it excellent for raw preparations.

Organic seeds.

Harvest Season: Fall

Maturity (days) T: 80

Code	Maturity (days) S	Seeds / pkg	Price
65-3818-01B	80	50	7,89 \$

2025 NOVELTIES – VEGETABLES



Pumpkin Hermes F1

A beautiful, medium-sized, dark orange pumpkin on a semi-bush plant. Tolerant to powdery mildew. Fruits are very round, well ribbed and have a large, solid handle.

Treated seeds.

Fruit Dimension H x D (cm) : 28 x 28

Fruit Weight (kg): 4–5

Colour: Dark Orange

Code	Maturity (days) S	Seeds / pkg	Price
65-4050-010	90	20	6,79 \$



Pumpkin Sunshine Yellow F1

Cute little yellow pumpkin, with a delicious flesh that has the sweetness and the texture of an Acorn type. Attractive yellow skin that will stay yellow after harvest. Pairs very well with Casperita and Orangita.

Treated seeds.

Fruit Dimension H x D (cm) : 8 x 11

Fruit Weight (kg): 0.5-0.7

Colour: Bright Yellow

Code	Maturity (days) S	Seeds / pkg	Price
65-4094-010	80	20	6,79 \$



Winter squash Ceres (Butternut) F1

Short season lover. Ceres is one of the earliest butternuts in W.H. Perron portfolio. It produces consistent 1.8 kg fruits on a full vining plant that is tolerant to powdery mildew. Excellent quality, dark orange flesh with a delicious nutty taste.

Treated seeds.

Colour: Tan

Plant Habit: Full Vine

Code	Maturity (days) S	Seeds / pkg	Price
65-4614-010	80	15	5,69 \$



Winter Squash Autumn Frost (Butternutt) F1

Unique, round and stocky, deeply ribbed butternut-type squash. The Autumn Frost winter squash ripens to a dark tan skin with a frosty overlay. This eye-catching squash has a rich butternut flavour and stores well up to 4 months.

Untreated seeds.

Colour: Frosted Tan

Fruit Shape: Square

Weight (kg): 1.1-1.8

Plant habit: Full Vine

Code	Maturity (days) S	Seeds / pkg	Price
65-4640-01N	85	15	6,79 \$

2025 NOVELTIES – VEGETABLES



Spinach Space F1

Top quality, vigorous, smooth-leaf variety from Europe. One of the best smooth leaf spinaches, with medium-dark green, upright, fleshy, broad leaves. The leaves are held up off the ground, so they stay clean. Best for summer and fall harvest.

Organic Seeds.

Colour: Medium Dark Green

Code	Maturity (days) S	Seeds / pkg	Price
65-5056-01B	50	350	5,69 \$



Spinach Mandolin F1

Outstanding, thick-leaved semi-savoy spinach variety. It is slow growing, making it especially good for warm weather production and retains its dark green colour regardless of stress. Strong white rust resistance.

Untreated Seeds.

Colour: Dark Green

Code	Maturity (days) S	Seeds / pkg	Price
65-5063-01N	52	350	5,69 \$



Bush Bean Celine Purple

The world's first purple-wax bean, pods are lavender on the outside and yellow on the inside and easy to locate on the open-habit plant. Celine combines high yields of refined pods with an unusual appearance and a sweet and nutty flavour. Very vigorous at the seedling stage. Pods average 8.75 cm to 11.25 cm long and 0.6 cm in diameter.

Organic seeds.

Pod length (cm): 8.75 to 11.25

Sieve: Small to medium

Code	Maturity (days) S	Seeds / pkg	Price
65-5279-01B	55	70	3,59 \$

2025 NOVELTIES – VEGETABLES

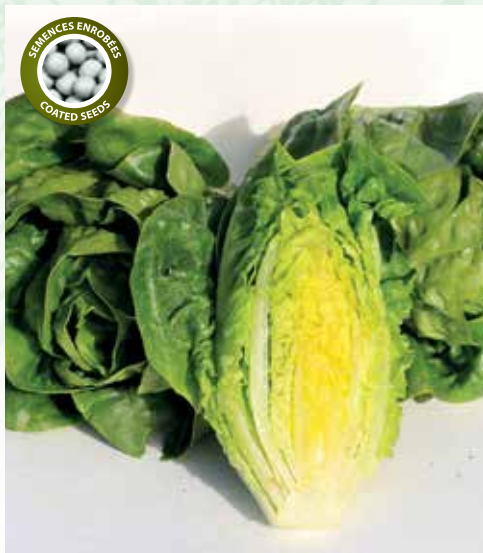

Mini Romaine Lettuce Sucrette

A small romaine lettuce known as “fat” because of its thick, almost sweet-tasting leaves. Small, densely packed head, highly resistant to heat and to bolting.

Coated and treated seeds.

Code	Maturity (days) S	Seeds / pkg	Price
65-5775-010	55	50	5,69 \$



Chocolate Brown Tomato Cappucino F1

Presenting the Cappucino original, flat and deeply ribbed tomato. Dark green delicious and firm fruits with marked shoulders, brown-red at turning stage and chocolate colour at full ripening. Big size tomatoes with an average weight of 250–300 g. A great addition to the garden!

Untreated seeds.

Plant size: indeterminate

Colour: Chocolate Brown

Fruit Weight (g): 250-230

Code	Maturity (days) T	Seeds / pkg	Price
65-8901-01N	75	15	10,09 \$



Cherry Tomato Cherry Blast F1

New trailing variety with proven resistance to Tomato Mosaic Virus and late blight, for a good production well into late summer. Excellent choice for hanging baskets. Heavy cropper blasted with delicious, sweet cherry fruits.

Untreated Seeds.

Plant size: Determinate, Small

Colour: Red

Fruit Weight (g): 25

Code	Maturity (days) T	Seeds / pkg	Price
65-9230-01N	47	20	7,89 \$

Seeds on a tape



Beet Boltardy – 140 s/t
69-0810-01N

UNTREATED «SEEDS ON A TAPE»

Discover our new line of «seed on a tape»! Seeds that have been inserted, in an optimal way, between two very thin layers of biodegradable fiber cloth.

A ribbon of seeds ensures the perfect density and prevents from overdosing.

In addition, nothing more simple: make a little furrow, lay down the pre-cut ribbon to the required length, moisture it and cover it with a thin layer of soil. Water. Wait. Admire. Easy no?

Tape Length: 6 meters

1 pkg 6,79\$



Carrot Mix – 425 s/t
69-1802-01N



Carrot Presto – 325 s/t
69-1825-01N



Mesclun Lettuce – 420 s/t
69-5610-01N



Leaf lettuce Green
140 s/t
69-5615-01N



Romaine Lettuce – 420 s/t
69-5780-01N



Bunching Onion White Lisbon
400 s/t
69-6705-01N



Radish Mix
200 s/t
69-8003-01N



Radish Cherry Belle
200 s/t
69-8015-01N

Seeds herbs discs



69-3112-01N Chives

A simple alternative to growing herbs without worrying about handling small seeds is to use seed discs.

Choose a container larger than the disc (8 cm dia.), Fill it with potting soil, line the surface to level and place the seed disc there. Then cover with a thin layer of vermiculite or potting soil and water thoroughly. It is recommended to place the container under an artificial light and to use a heating mat.

1 pkg (3 discs) 3,59 \$



69-7150-01N Italian Parsely



69-6511-01N Oregano



69-1120-01N Basil



69-3550-01N Coriander

SPROUTS & MICROGREENS

Price list of sprouts and microgreens found on page 11

CATEGORY : SPROUTS

Variety	Code	Format 50 g		Format : 125g *		Format : 250g *	
		1 pkg	Code	1 pkg	Code	1 pkg	
Bean Mung	65-9518-01B	4.59\$	65-9518-12B	7.89\$	65-9518-25B	14.49\$	
Alfalfa	65-9502-01B	4.59\$	65-9502-12B	7.89\$	65-9502-25B	14.49\$	
Energy mix (3)	65-9512-01N	4.59\$	65-9512-12N	7.89\$	65-9512-25N	14.49\$	
Vitality mix	65-9513-01N	4.59\$	65-9513-12N	7.89\$	65-9513-25N	14.49\$	

Variety	Code	Format 250 g		Format : 1 kilo *	
		1 pkg	Code	1 pkg	
Soya	65-9510-25N	5.69\$	65-9510-0KN	6.79\$	

CATEGORY : SPROUTS AND MICROGREENS

Variety	Code	Format 50 g		Format : 125g *		Format : 250g *	
		1 pkg	Code	1 pkg	Code	1 pkg	
Brocoli Raab	65-9503-01B	4.59\$	65-9503-12B	7.89\$	65-9503-25B	14.49\$	
Cabbage - red	65-9517-01N	6.79\$	65-9517-12N	16.59\$	65-9517-25N	30.69\$	
Clover - red	65-9504-01B	4.59\$	65-9504-12B	7.89\$	65-9504-25B	14.49\$	
Chickpea	65-9525-01B	3.59\$	65-9525-12B	5.69\$	65-9525-25B	6.79\$	
Kohlrabi - red	65-9520-01N	6.79\$	65-9520-12N	16.59\$	65-9520-25N	30.69\$	
Lentils - green	65-9516-01B	3.59\$	65-9516-12B	5.69\$	65-9516-25B	6.79\$	
Lentils - red	65-9534-01B	3.59\$	65-9534-12B	5.69\$	65-9534-25B	6.79\$	
Pea	65-9511-01B	3.59\$	65-9511-12B	5.69\$	65-9511-25B	6.79\$	
Pea Maple (speckled)	65-9535-01N	3.59\$	65-9535-12N	5.69\$	65-9535-25N	6.79\$	
Radish China Rose	65-9519-01B	4.59\$	65-9519-12B	7.89\$	65-9519-25B	14.49\$	
Radish Daikon	65-9509-01B	4.59\$	65-9509-12B	7.89\$	65-9509-25B	14.49\$	
Radish Rambo	65-9529-01B	6.79\$	65-9529-12B	16.59\$	65-9529-25B	30.69\$	
Radish Super Hong Vit	65-2715-01N	6.79\$	65-2715-12N	16.59\$	65-2715-25N	30.69\$	
Wheat Hard Red Winter	65-9527-01B	3.59\$	65-9527-12B	5.69\$	65-9527-25B	6.79\$	

CATEGORY : MICROGREENS

Variety	Code	Format 50 g		Format : 125g *		Format : 250g *	
		1 pkg	Code	1 pkg	Code	1 pkg	
Arugula (1)	65-9508-01B	4.59\$	65-9508-12B	7.89\$	65-9508-25B	14.49\$	
Coriandre Mono	65-9522-01B	3.59\$	65-9522-12B	5.69\$	65-9522-25B	6.79\$	
Dill	65-9531-01B	6.79\$	65-9531-12B	16.59\$	65-9531-25B	30.69\$	
Sunflower	65-9506-01B	3.59\$	65-9506-12B	5.69\$	65-9506-25B	6.79\$	

(1) Mucilaginous seeds: will release a gelatinous substance when in contact with water. It is recommended to water the base and drain well.

(2) Rinse/Drain: Rinse daily as often as recommended and drain well. Do not leave any standing water.

(3) Contains mucilaginous seeds (flax and arugula).

* The 10% discount is not applicable

SPROUTS



Vitality mix 65-9513



Soya 65-9510



Bean Mung 65-9518

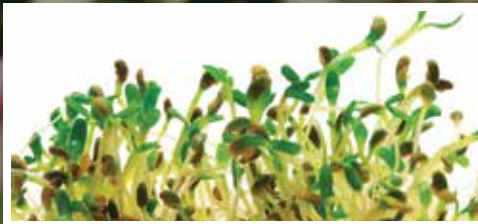

Alfalfa 65-9502

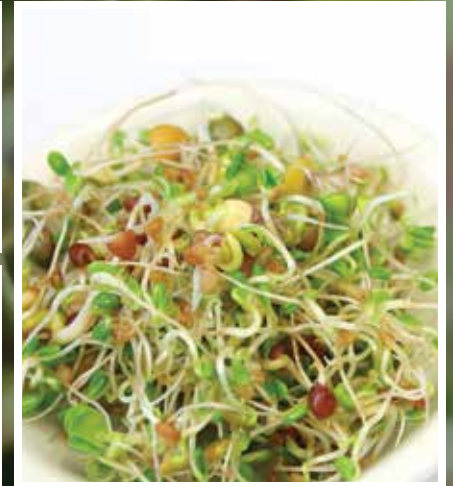

Energy mix 65-9512

SPROUTS MICROGREENS



Wheat Hard Red Winter 65-9527



Broccoli Raab 65-9503



Cabbage Red 65-9517



Kohlrabi Red 65-9520



Lentils Red 65-9534



Lentils Green 65-9516



Pea 65-9511



Chickpea 65-9525



Pea Maple 65-9535



Radish Daikon 65-9509



Radish Rambo 65-9529



Radish China Rose 65-9519



Radish Super Hong Vit 65-2715

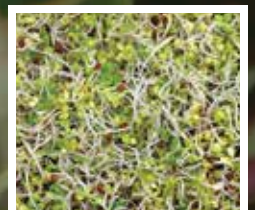

Clover Red 65-9504

MICROGREENS



Coriander 65-9522



Dill 65-9531



Arugula 65-9508

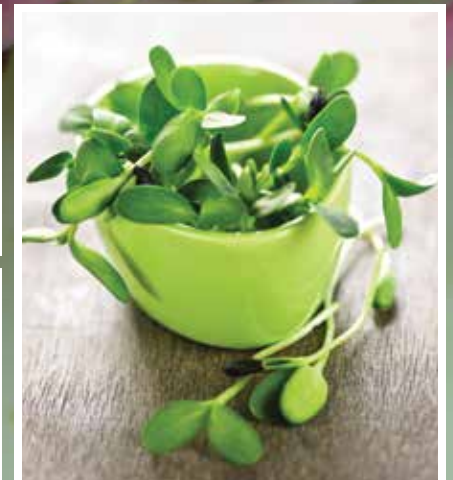

Sunflower 65-9506

SPROUTS & MICROGREENS

** Refer to the price list on page 10 and 11.

CATÉGORIE : SPROUTS

Variety	Code	Formulation	Soak (hours)	Rinse/ drain per day (2)	Days to harvest	Yield (weight ratio)
Alfalfa	65-9502	ORG	8-12	2-3	5-6	7:1
Bean Mung	65-9518	ORG	8-12	2-3	2-5	2:1
Energy mix (3)	65-9512	UNT	6-10	2	5-6	n / d
Soya	65-9510	UNT	1-12	2-3	2-6	2:1
Vitality mix	65-9513	UNT	6-10	2	5-6	n / d

CATEGORY : SPROUTS AND MICROGREENS

Variety	Code	Formulation	Soak (hours)	Rinse/ drain per day (2)	SPROUTS		MICROGREENS	
					Days to harvest	Yield (weight ratio)	Days to harvest	Yield (weight ratio)
Broccoli Raab	65-9503	ORG	8-12	2-3	3-6	5:1	5-14	3:1
Cabbage Red	65-9517	UNT	6-12	2-3	3-6	5:1	5-14	3:1
Chickpea	65-9525	ORG	8-12	2-3	2-4	2:1	10-14	1:1
Clover Red	65-9504	ORG	8-12	2-3	5-6	7:1	5-14	n/d
Kohlrabi Red	65-9520	UNT	6-12	2-3	5-7	5:1	7-14	3:1
Lentils Green	65-9516	ORG	8-12	2-3	2-3	2:1	n / d	n / d
Lentils Red	65-9534	ORG	8-12	2-3	2-3	2:1	n / d	n / d
Pea	65-9511	ORG	8-12	2	2-3	2:1	10-14	1:1
Pea Maple (speckled)	65-9535	UNT	8-12	2-3	3-6	5:1	5-14	1:1
Radish China Rose	65-9519	ORG	6-12	2-3	3-6	5:1	5-14	n/d
Radish Daikon	65-9509	ORG	6-12	2-3	3-6	5:1	5-14	n/d
Radish Rambo	65-9529	ORG	6-12	2-3	3-6	5:1	5-14	8:1
Radish Super Hong Vit	65-2715	UNT	6-12	2-3	3-6	7:1	5-14	12:1
Wheat Hard Red Winter	65-9527	ORG	12	2-3	2-3	n / d	8-10	n / d

CATEGORY : MICROGREENS

Variety	Code	Formulation	Soak (hours)	Days to harvest	Yield (weight ratio)
Aragula (1)	65-9508	ORG	No	5-14	10:1
Coriander	69-9522	ORG	No	14-21	3:1
Dill	65-9531	ORG	No	12-15	4:1
Sunflower	65-9506	ORG	No	8-12	6:1

- (1) **Mucilaginous seeds:** will release a gelatinous substance when in contact with water. It is recommended to water the base and drain well.
- (2) **Rinse/Drain :** Rinse daily as often as recommended and drain well. Do not leave any standing water.
- (3) Contains mucilaginous seeds (flax and arugula).

Important : Germs and sprouts production times, as well as their yield, can vary according to different criteria such as room temperature, water, temperature, seed lots, harvest stage, the lighting used, the density of the seedbed, the substrate, etc.

SPROUTS & MICROGREENS - ACCESSORIES

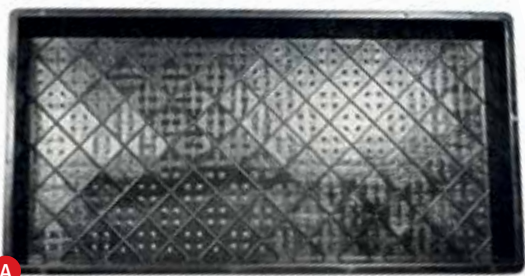

A A PROPAGATING TRAY 1020 WITH HOLES

This tray will last a long time, harvest after harvest cycle after cycle, due to the good quality and thickness of the plastic. Ideal for production of microgreens, wheatgrass, seedlings, cuttings, etc. Warning: this tray has holes for drainage.

06-6015-010 PROPAGATING TRAY 1020 WITH HOLES

LENGTH 21.4 INCH WIDTH 11 INCH HEIGHT 2.5 INCH

1 unit 8.00\$ 3 units or more 7.20\$ each

B 06-6020-010 MICROGREENS TRAY

This Microgreens tray is perfect for micro greens or wheatgrass. The shallow height allows you to easily and efficiently harvest your shoots as low as possible. The tray has holes for drainage, use the Terrafibre™ 100% biodegradable and soil-free culture medium.

LENGTH 20 INCH WIDTH 10 INCH DEPTH 1.25 INCH

1 unit 5.30\$ 3 units or more 4.77\$ each

C K601 CELL

Perfect size cells to produce sprouts at home. You receive 5 sheets of 6 cells for a total of 30 individual cells measuring 5.2 x 7 x 2.28 in each Fits into the propagating tray (code 06-3041-000).

06-3001-050 K601 CELL-PACK 6 CELLS

1 unit (5 trays/unit) 12.60\$ 3 units or more 11.34\$ each

06-6003-010 SEED SPROUTER SIPHON CAP

REPLACEMENT SIPHON CAP FOR BIOSTA SPROUTER.

1 unit 1.10\$ 3 units or more 0.99\$ each



06-6002-010 SEED SPROUTER

In the BIOSTA sprouting kit you can grow delicious sprouts in your own kitchen. Easy to handle, it provides you with fresh sprouts all year long. Healthy, economical, fun and educational for your children, you will harvest sprouts in only 72 hours. Made of sturdy plastic it has 3 levels of germination chambers.

Weight : 900 grams Diameter : 20 cm Height : 16,25 cm

1 unit 36.20\$ 3 units or more 32.58\$ each



06-6012-010 ORGANIC COTTON MILK BAG

Replacement bag in organic cotton for the Tofu and Sprouter Duo 06-6010-010.

1 unit 7.80\$ 3 units or more 7.02\$ each

COLLECTION: A GARDEN IN YOUR KITCHEN

The collection includes a seeds tray and 6 varieties of seeds to sprout that will each give three crops. This seed selection is ideal for beginners as it will provide rapid results. The use of seeds with different germination delays is recommended as it will extend your harvest. (125 g / package)

65-9500-010 COLLECTION 80.89\$ each



ALFALFA

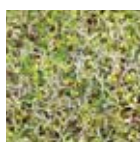

RED CLOVER



RADISH
DAIKON



ENERGY MIX



LENTIL



RED CABBAGE



2025 NOVELTY – FLOWERS



DAHLIA - *Dahlia pinata*



Black Forest™ Ruby

☼ 10-12 📏 20-23 🪴 5-12

Dahlia Black Forest™ Ruby has captivating black foliage, a robust knee-high stature and prolific flowering. Its bright red flowers stand out beautifully against the dark backdrop, making it perfect for gardens and container arrangements. With a range of semi-double to double flowers, it adds diversity and irresistible charm to any landscape.

Code	Spreading (cm)	Height (cm)	Seeds/pkg	Price
60-6246-010	25-30	50-65	50	7,89 \$



GUM TREE - *Eucalyptus globulus*



Styx

☼ 12-14 📏 20-25 🪴 7-9

If you enjoy playing with foliage in your landscaping, here's a beautiful plant with attractive large silver-blue leaves.

Code	Spreading (cm)	Height (cm)	Seeds/pkg	Price
60-7339-010	90	225	20	10,09 \$



HYPOESTES - *Hypoestes phyllostachya*



Splash Select™ White

☼ 11-12 🌿 21-24 🪴 7

Here's a plant that loves both sun and half-shade. It's ideal for adding colour, contrast or texture to landscapes. It's also low maintenance with a mounding habit, producing interesting white foliage with large, uniform patches; tolerates heat and drought once established.

Code	Spreading (cm)	Height (cm)	Seeds/pkg	Price
60-9919-010	30-35	10-15	25	5,69 \$



JUNCUS - *Juncus fuseables*



Twisted Arrow

☼ 12-16 🌿 18-24 🪴 5-6

A mixture of Juncus with both erect and twisted. Original in any arrangement.

Multiple seed coating

Code	Spreading (cm)	Height (cm)	Seeds/pkg	Price
61-0565-010	30-45	45-90	10	7,89 \$

2025 NOVELTY – FLOWERS

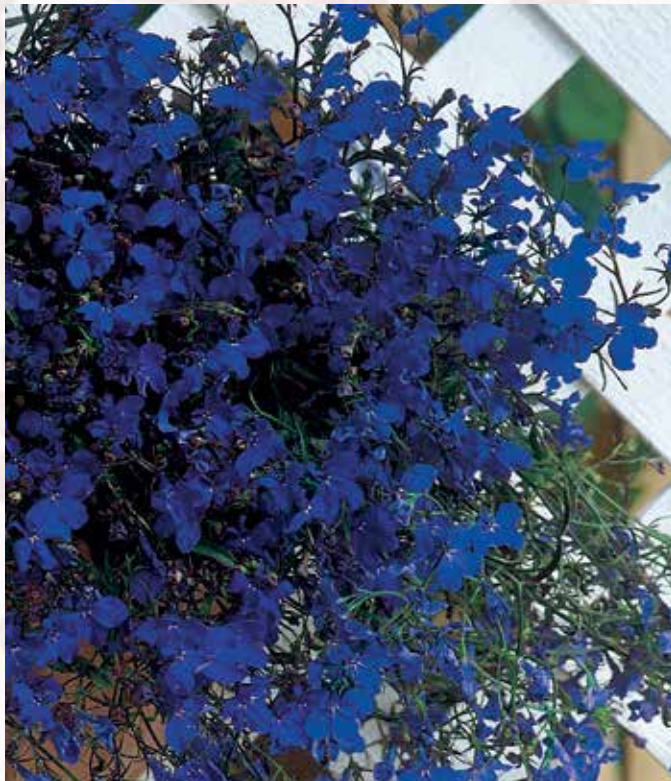

LOBELIA - *Lobelia erinus pendula*



Regatta Midnight Blue

☼ 12-15 ☾ 21-22 🌱 5-10

Vigorous plants flower profusely, cascading over the edge of hanging baskets, larger containers and colour bowls. Its trailing habit being perfect for mixed combinations and hanging baskets.

Multiple seed coating

Code	Spreading (cm)	Height (cm)	Seeds/pkg	Price
61-1357-010	25-30	15-20	20	3,59 \$



SNAPDRAGON - *Antirrhinum majus*



DoubleShot™ Mix

☼ 11-13 ☾ 18-22 🌱 4-10

DoubleShot™ is a large F1 garden snapdragons variety with beautiful double, open-faced flowers on sturdy, strongly branched plants. They produce sturdy, wind-resistant flower stems, even during the short-day periods of the year. Ideal for enhancing flower beds or containers, but can also be used as a long-lasting cut flower for the home.

Code	Spreading (cm)	Height (cm)	Seeds/pkg	Price
61-2790-010	30-35	45-50	75	6,79 \$

2025 NOVELTY – FLOWERS



PETUNIA - *Petunia multiflora*



Shake™ Raspberry

☀️ 9-11 🌿 18-20 🪴 7-12

A real colour breakthrough in seed-raised petunias. The Shake™ F1 variety combines unique flower colours with a compact habit. It will perform well in the garden, in addition to flowering early.

Coated seed

Code	Spreading (cm)	Height (cm)	Seeds/pkg	Price
61-5308-010	20-25	15-20	50	5,69 \$



PETUNIA - *Petunia x hybrida*



Easy WavE® Navy Velour

☀️ 12-16 🌿 22-24 🪴 7-12

Easy Wave® Silver F1 is ideal for landscape garden beds and adapt well to baskets and containers. Blooming freely all season long, they tolerate both heat and cooler conditions.

Coated seed

Code	Spreading (cm)	Height (cm)	Seeds/pkg	Price
61-5461-010	90-120	13-18	20	11,09 \$

TROPICAL PLANTS BY SEEDS



Asparagus densiflorus

Asparagus FUZZY Fern™ Frizz ☀️

🌱 28+ 📏 22-28 🪴 14-30

Fast growing this asparagus is very easy to care for. It is beautiful in containers, hanging baskets as well as in outdoor or indoor settings. It has a flexible and drooping foliage that can reach a meter in length. It likes bright light and tolerates partial shade.

Code	Height (cm)	Spreading (cm)	Seeds/pkg	Price
64-0715-010	60-90	60-90	25	7,89\$



Chamaedorea elegans

Parlor palm Collinea ☀️☀️

🌱 9-12 📏 25-30 🪴 20-42

This elegant, slow-growing palm has a beautiful architectural stature that complements any style of home. A reliable, low-maintenance houseplant all year round. This palm is able to live in low-light conditions! Chamaedorea elegans, also called Mountain Palm, is one of the best-selling houseplant palm species in the world.

Code	Height (cm)	Spreading (cm)	Seeds/pkg	Price
64-0810-010	120-240	60-90	25	7,89\$



Schefflera arboricola

Schefflera ☀️☀️

🌱 10-22 📏 23-29 🪴 30-60

Schefflera arboricola, is a superb shrub with a compact and bushy habit. This subtropical decorative beauty has glossy, oblong leaves. The shiny, leathery green leaves are arranged on their slender stems like an umbrella or like fingers on a hand. As a houseplant, the Schefflera is quite versatile and will adapt easily to a variety of conditions. It is also an excellent air purifier.

Code	Height (cm)	Seeds/pkg	Price
64-6890-010	30-60	25	7,89\$

Monstera deliciosa

☞ 23 ☞ 15 ☞

Monstera deliciosa, a liana native to tropical rainforests. Popular in the 1970's as a houseplant and now it's back in vogue, terribly prized for its huge, deeply lobed and perforated leaves. With its stems covered with aerial roots, its vigour and abundance will create a "jungle effect". This one fears excess water. The best place to install your Monstera may be near a window, but without direct sunlight. Wonderful indoor plant, resistant and easy to grow.

Code	Height (m)	Seeds/pkg	Price
64-6140-010	1	25	11,09\$



Lacy Tree Philodendron

☞ 23 ☞ 15-30 ☞

Ideal for beginners, the Philodendron tends to adapt easily to its environment. This one has foliage as interesting as Monstera. The young leaves are of a pale tender green. As they grow, they have an irregular shape that will make your plant stand out in your decor. A luminous place will make them happy, without exposing them to direct sunlight. It is important to let the soil dry slightly between waterings, especially in winter.

Code	Height (m)	Seeds/pkg	Price
64-6320-010	1.5	25	7,89\$



TROPICAL PLANTS BY SEEDS

Bird of Paradise

The *Strelitzia*, also called "bird of paradise" because of its bird-shaped flower, is native to South Africa. With its imposing stature and large leaves, it rarely goes unnoticed.

Flowering : It takes between five and seven years for a bird of paradise to reach full maturity. In appearance, they are quite similar, although the second is even more imposing. The colour of the flowers is also different. It is very rare that they bloom indoors. To support the bloom, the plant must live in an environment of 10 °C during the winter.

Care : The bird of paradise is easy to maintain, but requires an abundant light. It tolerates even the direct sun. Outside, it is better to place it under a shelter to prevent burns on the leaves. Water it regularly, especially in summer, on hot days, ideally in the evening to limit evaporation. Let it dry between watering's. Spray daily if the air is dry or shower it to reproduce the effect of a rain shower. Repot in the spring, in a larger container if it's cramped.



Strelitzia reginae

🌿 23 🌱 35-42 ☀️

Code	Height (m)	Seeds/pkg	Price
64-6902-010	2	25	11,09\$



Strelitzia nicolai

🌿 23 🌱 35-42 ☀️

Code	Height (m)	Seeds/pkg	Price
64-6908-010	2.5	25	11,09\$

TROPICAL PLANTS BY SEEDS



Grevillea robusta

Silky oak

☞ 23 ☞ 30 ☞ ☀

Grevillea also called “silky oak” adjusts as a low-growing houseplant. Plant in a medium to large containers and place it in a sunny, well-lit window with good air circulation. Grevillea is very drought tolerant, check your soil moisture regularly to make sure you don’t overwater. Prune after flowering and feed with a low phosphorus granular fertilizer in the spring. If you’re looking for a great houseplant, this one’s for you.

Code	Height (cm)	Seeds/pkg	Price
64-4725-010	60-100	25	10,09\$



Coffea arabica

Coffea

☞ 25 ☞ 14-21 ☞ ☀

An interesting plant with lush green foliage, fragrant flowers, and the familiar red coffee beans! It makes a nice houseplant, easy to grow for beginner gardeners. Coffee plants prefer bright, but indirect light and like the temperature between 21-25°C. The soil should be moist, but not soaking wet. The plant will need less water in the winter than in the summer.

Code	Height (cm)	Seeds/pkg	Price
64-2410-010	100	25	7,89\$



Mimosa pudica

Sensitive - Mimosa pudica

☞ 25 ☞ 35 ☞ ☀

Mimosa pudica is certainly the most popular of plant curiosities since these leaves close when touched, hence its name sensitive. She prefer bright, but indirect light.

Code	Height (cm)	Seeds/pkg	Price
64-6125-010	50	75	4,59\$

ANNUAL DECORATIVE FOLIAGE & ORNAMENTAL GRASSES



Love-Lies-Bleeding Dark Red



Kale - Flowering Nagoya Mix F1



Love-Lies-Bleeding Carnival



Love-Lies-Bleeding Velvet Curtains



Kale - Flowering Crane™ Feather mix



Kale - Palm Toscano



Kale - Flowering Glamour™ Red F1

LOVE-LIES-BLEEDING - *Amaranthus gangeticus* ☀️

✂️ 🌸 10-12 📏 21-24 🪴 10-15

60-0590-010 - Carnival

A striking foliage plant with fiery shades of yellow and red contrasting with the bronze leaf. Tall purple flowers are produced in late summer. A focal point for any display.

Height (cm): 120 Spreading (cm): 60-90

1 pkg 50 s/p 3.59 \$

LOVE-LIES-BLEEDING - *Amaranthus caudatus* ☀️

✂️ 🌸 10-12 📏 21-24 🪴 8-10

60-0586-010 - Dark Red

Bizarre variety with clusters of striking, long, drooping flowers that develop into colourful seed panicles later in the season.

Height (cm): 90 Spreading (cm): 60-90

1 pkg 175 s/p 3.59 \$

✂️ 🌸 10-12 📏 21-24 🪴 8-10

60-0588-010 - Velvet Curtains

This amaranth displays uniform dark crimson foliage and flower spikes creating a nice contrast in your garden.

Height (cm): 150 Spreading (cm): 90-120

1 pkg 175 s/p 3.59 \$

KALE - FLOWERING - *Brassica oleracea* ☀️

✂️ 🌸 12-17 📏 21-24 🪴 5-7

60-3850-010 - Crane™ Feather mix

Crane™ Feather is a flowering kale designed for cut flower production. Its texture will bring a contemporary touch to any floral arrangement

Height (cm): 60-90 Spreading (cm): 15

1 pkg 20 s/p 6.79 \$

🌸 10-11 📏 18-21 🪴 4-6

60-3806-010 - Glamour™ Red F1

The fringed leaves make them shiny with a more intense rose colour that contrasts with the darker exterior leaves. The colours intensify when the temperature is below 15 °C.

Height (cm): 30

Head diameter (cm) : 25-30

1 pkg 40 s/p 6.79 \$

KALE - FLOWERING - *Brassica oleracea* ☀️

🌸 9-10 📏 21 🪴 5-10

60-3820-010 - Nagoya Mix F1

The leaves are heavily fringed and show the most beautiful colours with the onset of cold weather.

Height (cm): 25-30 Spreading (cm): 20

1 pkg 40 s/p 3.59 \$

KALE - PALM - *Brassica oleracea* ☀️

🌸 9-10 📏 18-21 🪴 5-10

60-3866-010 - Toscano

Very different with large leaves that make it look like a palm tree, this ornamental cabbage looks exotic and brings originality to your flowerbed. Resistant to the cold, the plants will stand until hard frost.

Height (cm): 60-80 Spreading (cm): 45-60

1 pkg 50 s/p 4.59 \$



ANNUAL DECORATIVE FOLIAGE & ORNAMENTAL GRASSES



Coleus Premium Sun Chocolate Covered Cherry



Coleus Giant Exhibition™ Mix



Coleus Wizard® Mix



Corsican Mint Mini mint



Bunny Tail Bunny Tail Dwarf



Cat Grass Tabby



Dichondra Silver Falls

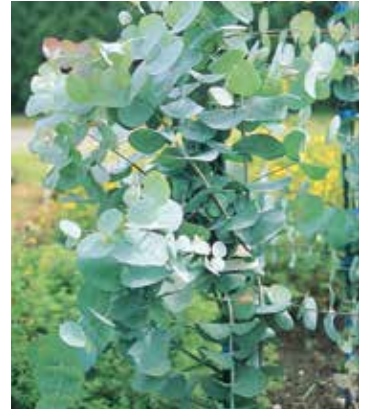

Gum Tree Silverdrop



Dracaena

COLEUS - Plectranthus scutellarioides ☀️🌿🌿

🌸 11-14 📏 22-24 🪴 4-5

60-5015-010 - Premium Sun Chocolate Covered Cherry
The rose centre on each leaf is surrounded by deep mahogany and edged with a thin green margin. Non fading unique colour, this coleus performs well in both shade and sun. Ideal for border and containers.

Pelleted seed

Height (cm): 30-35 Spreading (cm): 25-30

1 pkg 15 s/p 7.89 \$

COLEUS - Plectranthus scutellarioides ☀️🌿🌿

🌸 12-15 📏 22-24 🪴 4-5

60-5030-010 - Wizard® Mix

Plants have more branches than those of the Rainbow series. A lovely blend of pastel shades of golden yellow, pineapple yellow, pink, rose, scarlet red and blood red.

Height (cm): 30-35 Spreading (cm): 25-30

1 pkg 100 s/p 4.59 \$

✂️🌸 11-15 📏 20-24 🪴 8-10

60-5070-010 - Giant Exhibition™ Mix

Finally available in a mixture of colours, Giant Exhibition are the most vigorous large coleus propagated from seeds on the market. Plant them in a patio container or in your garden and be amazed by their showy colours.

Height (cm): 50 Spreading (cm): 25-35

1 pkg 25 s/p 10.09 \$

DICHONDRA - Dichondra argentea ☀️🌿

🌸 11-12 📏 22-24 🪴 4-7

60-6409-010 - Silver Falls

Distinct with its long silvery stems covered with small, elegant, rounded silver leaves, Dichondra displays vigorous growth and heat tolerance under full sun conditions. It is also a nice ground cover but requires well-drained soil; keep a 5-8 cm space between the plants.

Height (cm): 5-8 Spreading (cm): 90-120

1 pkg 10 s/p 7.89 \$

DRACAENA - Dracaena indivisa ☀️🌿🌿

🌸 30 📏 21 🪴 40

60-6850-010 - Dracaena

A popular, narrow-leaved variety for outdoor planters.

Height (cm): 60

1 pkg 100 s/p 4.59 \$

GUM TREE - Eucalyptus gunnii ☀️🌿

✂️🌸 16 📏 22-24 🪴 14-21

60-7329-010 - Silverdrop

Grown primarily for its spectacular silvery-blue small round leaves and used in fresh or dried flower arrangements.

Height (cm): 60-90 Spreading (cm): 30-60

1 pkg 30 s/p 6.79 \$

BUNNY TAIL - Lagurus ovatus ☀️🌿

🌸 16 📏 18-21 🪴 10-14

61-0610-010 - Bunny Tail

An annual, this grass produces small 3-5 cm wide inflorescences, resembling a rabbit's tail. Use in pots or for cut flowers.

Height (cm): 50 Spreading (cm): 20-30

1 pkg 75 s/p 6.79 \$

CAT GRASS - Hordeum vulgare variegata ☀️🌿

🌸 3-4 📏 18-21 🪴 7-10

60-9820-010 - Tabby

Not just an outstanding seasonal ornamental or accent plant, variegated cat grass provides vitamins and fibre for your cat's diet and keeps them from chewing on your prized houseplants. Edible for human too, it can be freshly juiced or dried to use as a powder.

Height (cm): 10-15

1 pkg 200 s/p 4.59 \$

CORSICAN MINT - Mentha requienii ☀️🌿

🌸 5-7 📏 18-21 🪴 5-7

61-4605-010 - Mini mint

This ornamental mint produces very tiny leaves with a creeping habit and covering as mosses. Easy and fast growing in a container or used as a groundcover. The leaves are highly fragrant but do not have a palatable flavour and are non-toxic. Use 1 plug in a 10 cm container.

Multipellet seeds

Height (cm): 3-5 Spreading (cm): 15-30

1 pkg 25 s/p 6.79 \$



ANNUAL DECORATIVE FOLIAGE & ORNAMENTAL GRASSES



Rice Black Madras



Ornamental Millet Purple Majesty

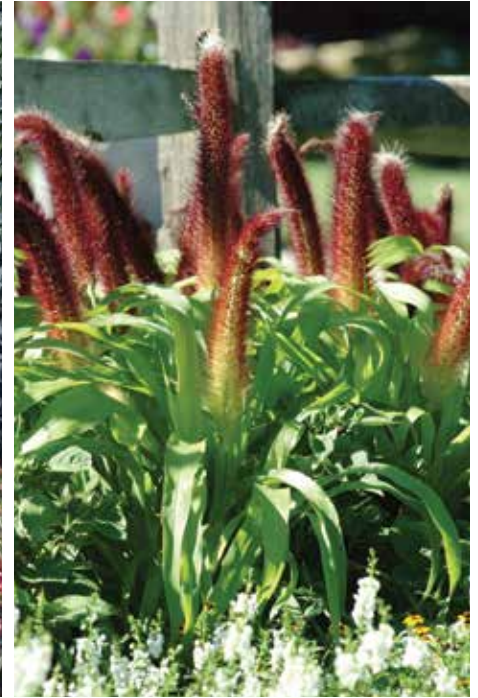

Ornamental Millet Jade Princess F1



Castor Bean Gibsonii



Cardoon Silver Leaf



Dusty Miller Silverdust

RICE - *Oryza sativa*



☼ 8-10 📏 20-24 🗑️ 7-14

61-4658-010 - Black Madras

Easy to grow, new and exotic, this ornamental rice looks like dracena spikes, turning from green to purple in the sun. Very attractive in containers or as a border plant, it's a sun lover and needs regular watering. Under nice fall conditions, you may even harvest some rice and eat it!

Height (cm): 40 Spreading (cm): 20-25

1 pkg 30 s/p 3.59 \$

CARDOON - *Cynara cardunculus*



☼ 6-8 📏 15-20 🗑️ 10-21

60-6039-010 Silver Leaf

Used as an accent plant, this silver leaf variety is surprising in a large bed, bringing eccentricity to your landscape.

Height (cm): 70-90 Spreading (cm): 60-90

1 pkg 50 s/p 7.89 \$

ORNAMENTAL MILLET - *Pennisetum glaucum*



☼ 6-8 📏 22-25 🗑️ 2-3

61-4979-010 - Jade Princess F1

Pennisetum glaucum Jade Princess F1 has a stunning chartreuse coloured foliage offering a beautiful contrast with its brown pollen-less cob. Note that to perform well, it requires warmer temperatures than other millets.

Height (cm): 61-76 Spreading (cm): 45-60

1 pkg 10 s/p 7.89 \$

☼ 7-8 📏 22-25 🗑️ 2-3

61-4978-010 - Purple Majesty

The striking purple-leaved blades and spikes, that resemble cattails, are distinctly different from all other ornamentals. Use the spikes in floral arrangements and keep the mature plant until fall, for Hallowe'en scenes. Easy to grow, young plants are green and turn dark purple in full sun.

Height (cm): 120-150 Spreading (cm): 20-30

1 pkg 10 s/p 7.89 \$

CASTOR BEAN - *Ricinus communis*



☼ 8-12 📏 21-22 🗑️ 6-12

61-6730-010 - Gibsonii

Superb in full sun, used as specimen plants or as an exotic hedge. Use alone in a corner, or in a group for an exotic look. Produce red fruits.

Please note that all parts of the plant are poisonous.

Height (cm): 150 Spreading (cm): 90

1 pkg 7 s/p 7.89 \$

DUSTY MILLER - *Senecio cineraria*



☼ 11-12 📏 22-24 🗑️ 3-5

60-4039-010 - Silverdust

Its silver-dusted, intricately defined leaves are a dramatic addition to your garden, especially among brightly coloured annuals.

Height (cm): 25 Spreading (cm): 25

1 pkg 150 s/p 3.59 \$



Anise Hyssop Astello Indigo F1



Ageratum Aloha Blue F1



Alyssum Clear Crystal® White



Alyssum Wonderland®
Deep Rose



Angelonia Serenita® Pink F1



Snapdragon Snaptini™ Mix F1



Snapdragon Twinny™ Peach F1



Snapdragon Mme Butterfly™ Mix F1



Asarina Climbing Mix

ANISE HYSSOP - Agastache hybrida



☞ ✂️ 🌸 15 📏 18-20 🏠 7-14

60-0211-010 Astello Indigo F1

This 2012 Fleuroselect Gold Medal winner is perfectly suited for use in containers as well as in garden beds, by itself or in mixed combinations. The beautiful, upright flower spikes are fully covered with fragrant, deep indigo-blue flowers with a delightful mint scent that attracts butterflies and bees. It is drought tolerant, easy to care for and it is at its best in more moderate conditions.

Height (cm): 50-60 Spreading (cm): 35

1 pkg 20 s/p 5.69 \$

AGERATUM - Ageratum houstonianum



🌸 12-14 📏 20-22 🏠 7-14

60-0232-010 Aloha Blue F1

Bouquet of lavender-blue flowers grouped above the plant. The ageratum Aloha Blue is ideal for landscaping borders and in containers.

Pelleted seed

Height (cm): 15-20 Spreading (cm): 15-20

1 pkg 100 s/p 6.79 \$

ALYSSUM - Alyssum maritimum



☞ 🌸 8-10 📏 21-24 🏠 5-8

60-0409-010 Clear Crystal® White

This tetraploid variety produces more flowers than a normal alyssum since it does not waste its energy producing seeds. You will really enjoy its large and fragrant white bloom and its stronger performance in containers and in the garden.

Filmcoat seed.

Height (cm): 15-25 Spreading (cm): 30-35

1 pkg 100 s/p 3.59 \$

☞ 🌸 9 📏 21-24 🏠 5-8

60-0425-010 Wonderland® Deep Rose

Early bloomer series that flowers abundantly.

Height (cm): 8 Spreading (cm): 30

1 pkg 350 s/p 3.59 \$

ANGELONIA - Angelonia angustifolia



☞ 🌸 13-14 📏 23 🏠 4-5

60-0667-010 Serenita® Pink F1

Elegant yet tough plants bring long-lasting color with very little maintenance. These look beautiful in mixed combos on the patio or create a soothing sea of soft color in the landscape. This heat-tolerant plants is a good replacement for alyssum and ageratum.

Pelleted seed

Height (cm): 30-35 Spreading (cm): 30-35

1 pkg 10 s/p 6.79 \$

SNAPDRAGON - Antirrhinum majus



☞ 🌸 9-11 📏 21-24 🏠 4-10

61-2690-010 Snaptini™ Mix F1

The mix includes Burgundy Bicolor, Peach, Red, Rose Bicolor, Sunglow, White Lavender, Scarlet, Yellow.

Pelleted seed

Height (cm): 15-20 Spreading (cm): 15-20

1 pkg 100 s/p 3.59 \$

☞ 🌸 10-12 📏 21 🏠 4-10

61-2763-010 Twinny™ Peach F1

2010 All-America Selections winner, it is the first compact snapdragon with a double butterfly flower form, showing a blend of peach tones. Match it with blue tones or purple foliage and your garden will be a knockout.

Height (cm): 20-30 Spreading (cm): 20-25

1 pkg 100 s/p 6.79 \$

☞ ✂️ 🌸 16-18 📏 21-24 🏠 4-10

61-2780-010 Mme Butterfly™ Mix F1

Double-centered, azalea-like flowers on vigorous, basebranching plants. Bright colour range and nice for cutting.

Height (cm): 60-75 Spreading (cm): 35-40

1 pkg 100 s/p 4.59 \$

ASARINA - Asarina scandens



☞ 🌸 18-21 📏 18-20 🏠 14-20

60-0780-010 Climbing Mix

This flower, sometimes called "Twining Snapdragon", features a dense screen of soft green leaves on a fast-growing vine, crowned with rich snapdragon-like trumpets of small pink, scarlet, violet and blue flowers. It takes 18 weeks from seeds to festive flowers that attract hummingbirds.

Height (cm): 350

1 pkg 15 s/p 4.59 \$



Begonia Santa Cruz® F1



Begonia Bossa Nova™ Red F1



Begonia Fiona™ Red F1



Begonia Ambassador Mix F1



**Begonia Sun Dancer™
Yellow Red Picotee F1**



**Begonia AmeriHybrid®
Picotee Sunburst F1**



**Begonia AmeriHybrid® Ruffled
Scarlet Red F1**

BEGONIA - Begonia boliviensis



🌸 14-16 🌿 22-23 🪴 7-14

60-1666-010 Santa Cruz® F1

First begonia boliviensis from seeds, this wonderful variety produces an abundance of fiery bright-red bell-shaped flowers, ideal to use in hanging basket and large patio containers. Drought and rain tolerant, it thrives in full sun and shade and it does not need special care. It branches naturally without pinching compared to vegetative propagated varieties. Use 3 to 5 plants in a 25 cm hanging basket.

Pelleted seed

Height (cm): 30-40 Spreading (cm): 40-50

1 pkg 15 s/p 10.09 \$

🌸 15-18 🌿 23-25 🪴 7-14

60-1676-010 Bossa Nova™ Red F1

Brilliant self-cleaning red blooms cover. The well branched plants with shorter internodes look stunning in large container or hanging basket. It does not need pinching compared to vegetative propagated varieties.

Pelleted seed

Height (cm): 30-40 Spreading (cm): 40-50

1 pkg 15 s/p 10.09 \$

BEGONIA - Begonia semperflorens



🌸 11-13 🌿 22-26 🪴 15-20

60-1296-010 Fiona™ Red F1

Fleuroselect Gold Medal winner. Begonia semperflorens Fiona™ Red F1 is like a powerful explosion of colours in any gardens or containers. Semi-double and self-cleaning flowers that offer continuous colours throughout summer and until the first frost.

Pelleted seed

Height (cm): 20-25 Spreading (cm): 20-25

1 pkg 50 s/p 6.79 \$

🌸 10-12 🌿 22-26 🪴 15-20

60-1330-010 Ambassador Mix F1

Very beautiful heat tolerant mixed plants, with rich green foliage, 10 days earlier than similar varieties.

Pelleted seed

Height (cm): 30 Spreading (cm): 25-30

1 pkg 125 s/p 6.79 \$

BEGONIA - Begonia Tuberhybrida



🌸 16-21 🌿 22-26 🪴 15-20

60-1457-010 Sun Dancer™ Yellow Red Picotee F1

Produce attractive cascades of extra-large fully double, yellow flowers edged with red, 5-12 cm (2.5-5").

Pelleted seed

Height (cm): 25-30 Spreading (cm): 30-40

1 pkg 25 s/p 7.89 \$

🌸 18-23 🌿 22-26 🪴 15-20

AmeriHybrid® F1 Series

The tuberous begonia with the largest flowers in the world! On an upright habit, has a consistent double shape flower of 13 to 23 cm in diameter. Needs from 14 to 16 hours of light per day to favour good growth and promote the production of flowers.

Pelleted seed

60-1423-010 AmeriHybrid® Picotee Sunburst F1

Here is a beautiful two-colored tuberous begonia, yellow with red borders.

60-1446-010 AmeriHybrid® Ruffled Scarlet Red F1

Height (cm): 35-50 Spreading (cm): 25-30

1 pkg 25 s/p 7.89 \$





Begonia Nonstop® Mix F1



Begonia Nonstop® Mocca Mix F1

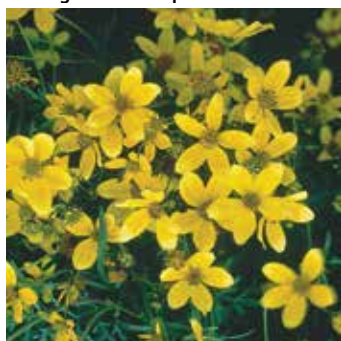

Bidens Golden Eye



Begonia Funky® Pink F1



Calendula Neon



Calendula Playtime Mix



Begonia Viking® XL Red on Chocolate F1



Calendula Crown Orange

BEGONIA - Begonia tuberhybrida



🌸 17-20 📏 22-26 🪴 15-20

60-1590-010 Nonstop® Mix F1

With their large double and semi-double 8 cm flowers, Nonstop begonias are renowned for their garden performance and heat tolerance.

Pelleted seed

Height (cm): 25 Spreading (cm): 30

1 pkg 25 s/p 7.89 \$

🌸 17-20 📏 22-26 🪴 15-20

60-1630-010 Nonstop® Mocca Mix F1

The chocolate-colored leaves of this tuberous begonia contrast exquisitely with the vibrant flower colors creating a burst of color.

Pelleted seed

Height (cm): 25 Spreading (cm): 30

1 pkg 25 s/p 7.89 \$

BEGONIA - Begonia x hybrida



🌸 16-20 📏 22-26 🪴 15-20

60-1232-010 Viking® XL Red on Chocolate F1

Its intense deep bronze foliage earned it an AAS winner award. The colour tones shine and give a splendid charm to any garden. The plant, covered with vibrant red flowers, keeps its shape well. The impressive «XL» height makes it perfect for landscaping and containers.

Pelleted seed

Height (cm): 70-85 Spreading (cm): 80-90

1 pkg 15 s/p 7.89 \$

BEGONIA - Begonia x hybrida



🌸 15-18 📏 22-23 🪴 10-14

60-1245-010 Funky® Pink F1

Funky® Pink F1 is a semi-trailing begonia producing large and attractive double pink flowers all summer long. Very nice in hanging baskets or containers, it is also amazing as a bedding plant.

Pelleted seed

Height (cm): 25 Spreading (cm): 30-45

1 pkg 15 s/p 7.89 \$

BIDENS - Bidens aurea



🌸 10-12 📏 20 🪴 7-10

60-1742-010 Golden Eye

Improved variety with golden yellow, 5 cm flowers on a compact plant.

Height (cm): 45 Spreading (cm): 30

1 pkg 50 s/p 10.09 \$

CALENDULA - Calendula officinalis



🌸 12 📏 21 🪴 7-10

60-2254-010 Crown Orange

Fleuroselect winner, for the lushness of this big double orange flower, with a dark heart. Preferred by the judges for its beautiful and uniform flower, reminding the elegant look of Gerbera. A great addition for your flower bouquets. Flower size 8-10 cm in diameter.

Height (cm): 40-50 Spreading (cm): 30

1 pkg 50 s/p 4.59 \$

🌸 12 📏 21 🪴 7-10

60-2274-010 Neon

This variety wears very nice ultra double flowers with densely set deep orange petals edged in burgundy. It gives a wonderful glowing effect in landscapes or bouquets.

Height (cm): 70 Spreading (cm): 30

1 pkg 50 s/p 4.59 \$

🌸 12 📏 21 🪴 7-10

60-2250-010 Playtime Mix

A beautiful mix of pastel and buff colours for single and semi-double flowers with sometimes dark or yellow centres.

Height (cm): 40-50 Spreading (cm): 30

1 pkg 50 s/p 5.69 \$



Calendula Snow Princess



Canna South Pacific™ Ivory F1



Canna South Pacific™ Scarlet F1



Canna South Pacific™ Orange F1



Canna South Pacific™ Rose F1



Celosia Century Mix



Aster Princess Mix

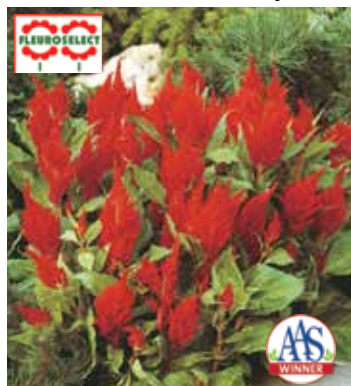

Celosia Fresh Look Red



Celosia Asian Garden



Cornflower Fireworks Mix

CALENDULA - *Calendula officinalis*



✂️ 🌸 12 📏 21 🗑️ 7-10

60-2269-010 Snow Princess

This variety was rewarded Fleuroselect for its unique colour range in flower. In bud, the flower seems light yellow, but once fully opened, the 7 cm double flower is almost white with either a dark or a yellow centre.

Height (cm): 70 Spreading (cm): 30

1 pkg 50 s/p 3.59 \$

ASTER - *Callistephus chinensis*



✂️ 🌸 14-15 📏 18-20 🗑️ 10-14

61-6360-010 Princess Mix

Branching plant, covered with 8 cm flowers. Recommended for cut flowers or flower beds. Giant, double-flowered variety.

Height (cm): 70 Spreading (cm): 30-45

1 pkg 100 s/p 3.59 \$

CANNA - *Canna x generalis*



🌿 🌸 11-15 📏 23-26 🗑️ 7-10

South Pacific™ F1 series

This series is more vigorous, more uniform, and has more basal branching than comparison cannas. Pollinator gardens will love this series of a canna that sports uniformly colour flowers over a long blooming period. This series is grown from seeds, not tubers, meaning less chance of succumbing to the disease.

60-2361-010 South Pacific™ Scarlet F1

60-2364-010 South Pacific™ Orange F1

60-2365-010 South Pacific™ Rose F1

60-2369-010 South Pacific™ Ivory F1

Height (cm): 60-80 Spreading (cm): 30-60

1 pkg 15 s/p 14.49 \$

CELOSIA - *Celosia argentea*



🌿 ✂️ 🌸 14-16 📏 20-25 🗑️ 7-10

60-3415-010 Asian Garden

AAS winner. Asian Garden celosia blooms on sturdy and well-branched stems and will keep its bright pink color all summer long, holding up through the first frosts. This celosia is a pollinator magnet, making it a sure bet for pollinator-friendly gardens.

Height (cm): 75-100 Spreading (cm): 30-45

1 pkg 50 s/p 5.69 \$

CELOSIA - *Celosia plumosa*



✂️ 🌸 12-13 📏 21-24 🗑️ 7-10

60-3350-010 Century Mix

Extremely long plumes, about 30 cm long. Very popular with municipalities and landscapers.

Height (cm): 40 Spreading (cm): 20

1 pkg 100 s/p 3.59 \$

🌸 12-13 📏 22-25 🗑️ 7-14

60-3363-010 Fresh Look Red

Like eternal flames, these new celosias carry their feathery red flower plumes all summer long. They are incredibly robust with excellent garden performance.

Pelleted seed

Height (cm): 35 Spreading (cm): 30-45

1 pkg 100 s/p 4.59 \$

CORNFLOWER- *Centaurea cyanus*



🌿 ✂️ 🌸 16 📏 17 🗑️ 8-14

60-3570-010 Fireworks Mix

Easy to grow, this bright mixture includes red, blue and white flowers. Ideal in mass plantings or as a border plant, it also makes an excellent cut flower. It can be sown directly in the garden in warmer climates.

Height (cm): 75 Spreading (cm): 20

1 pkg 150 s/p 3.59 \$



Cosmos Limara Lemon



Cosmos Sonata™ Mix



Cosmos Antiquity



Cosmos Xanthos



Cosmos Cosmic Mix



Cosmos Sensation Mix



Cosmos Double Click Mix



**Cosmos Double Click
Rose Bonbon**



**Cosmos Double Click
Bicolour Violet**



Cosmos Double Click White



Cosmos Sensation Picotee

COSMOS - Cosmos bipinnatus



10-12 16-18 5-7

60-5620-010 Sonata™ Mix

The most popular cosmos it produces compact, well branched and floriferous plants.

Height (cm): 60 Spreading (cm): 30-35

1 pkg 75 s/p 4.59 \$

10-12 16-18 5-7

60-5630-010 Antiquity

Early to flower and a well-branched plant, Antiquity is the only cosmos on the market with flowers in shades of salmon pink. It displays up to 20 - 7 cm flowers on the same plant, thus creating a wonderful bouquet. As with all very floriferous plants, cut all dead flowers after flowering, this will help plants produce new flower buds.

Height (cm): 50-75 Spreading (cm): 30-35

1 pkg 75 s/p 4.59 \$

10-12 16-18 5-7

60-5652-010 Xanthos

This cosmos adds a new colour to the compact Cosmos range. An absolute breakthrough in breeding! It produces 6 cm stunning soft yellow flowers. Very floriferous, plants are dwarf, uniform and well branched. Remove dead flowers to help new flowers.

Height (cm): 60 Spreading (cm): 40-45

1 pkg 50 s/p 5.69 \$

COSMOS - Cosmos bipinnatus



8-12 18-20 5-7

Double Click series

Impressive, the Double Click series produces double and semi-double flowers on long plants.

60-5670-010 Double Click Mix

They bloom all summer long in a mixture of white, soft pink and carmine red flowers.

60-5675-010 Double Click Rose Bonbon

Winner of a Fleuroselect mention, it is the first bipinnatus cosmos with fully double, rose like, bright pink flowers.

60-5678-010 Double Click Bicolour Violet

A Fleuroselect mention for this beautiful, double and semi-double 7 cm, purple and white flower. Appreciated for its garden performance and spectacular impact in flowerbeds.

60-5679-010 Double Click White

Doubly impressive, the white version of Cosmos Double Click will seduce you with its double and semi-double 8 cm flowers bringing light to your landscape.

Height (cm): 60-90 Spreading (cm): 60

1 pkg 25 s/p 3.59 \$

COSMOS - Cosmos bipinnatus



10-12 18-20 5-7

Sensation series

Annual plant, with very large multicolored flowers, very easy culture, for the flowering of a rural massif from June to October.

60-5690-010 Sensation Mix

Single 10 cm blooms in shades of red, pink and white.

60-5691-010 Sensation Picotee

Wonderful white flowers edged shades of pink to red.

Height (cm): 100-120 Spreading (cm): 20-30

1 pkg 75 s/p 3.59 \$

COSMOS - Cosmos sulphureus



7-8 18-21 5-7

60-5602-010 Limara Lemon

Producing a multitude of creamy lemon yellow blooms set off by a darker golden eye, Limara is compact and floriferous. Easy to grow, preferring poor soils, it makes an excellent border plant for an annual flower garden or a great specimen in a patio container.

Height (cm): 20 Spreading (cm): 10-15

1 pkg 75 s/p 4.59 \$

7-8 18-21 5-7

60-5615-010 Cosmic Mix

A wonderful border plant for annual beds, Cosmic is covered with a multitude of double and semi-double flowers.

Height (cm): 30 Spreading (cm): 20-25

1 pkg 75 s/p 4.59 \$





Tickseed Dwarf Selection



Cuphea Sweet Talk™ Deep Pink



Dahlia Figaro™ Mix F1



Dahlia Black Beauty™



Dahlia Fireworks™ Mix



Cleome Sparkler™ Blush F1



Tickseed Presto



Dahlia Harlequin™ Mix F1

CLEOME - Cleome spinosa



☀️ 10-12 🌙 day 28 - night 20 🪴 4-10

60-4451-010 Sparkler™ 2.0 Blush F1

You'll love 'Sparkler™' for its friendly growth and bushier plant habit. It is covered with flower spikes. This is the first hybrid Cleome available on the market and you will notice the difference by its better germinating seeds and unequalled flowering.

Height (cm): 90-110 Spreading (cm): 60-90

1 pkg 20 s/p 10.09 \$

TICKSEED - Coreopsis grandiflora



🪴 11-12 ☀️ 15-18 🪴 4-6

60-5432-010 Presto

What makes Presto unique are its 6 cm double and semi-double flowers in combination with its natural short and perfect ball shape plant habit. Easy to grow it also attracts butterflies. A Fleuroselect prize winner.

Height (cm): 15-20 Spreading (cm): 15-20

1 pkg 50 s/p 6.79 \$

TICKSEED - Coreopsis tinctoria



🪴 6-8 ☀️ 24 🪴 5-10

60-5422-010 Dwarf Selection

Coreopsis tinctoria is a very ornamental annual plant with numerous bright yellow flowers with a red centre. Very pretty and easy to care for, this plant thrives in a well-drained soil and full sun and it is often used for mass planting or to provide colour in an empty area. Often self-seeding it attracts butterflies.

Height (cm): 40-60 Spreading (cm): 30

1 pkg 150 s/p 6.79 \$

CUPHEA - Cuphea procumbens



☀️ 12-13 🌙 20-25 🪴 3-10

60-5935-010 Sweet Talk™ Deep pink

Perfect plant for a pollinator garden! The beautiful cuphea flowers are a natural source of nectar that attract pollinators, including bees and hummingbirds.

Height (cm): 20-36 Spreading (cm): 20-36

1 pkg 15 s/p 10.09 \$

DAHLIA - Dahlia x hybrida



🪴 10-11 ☀️ 20-23 🪴 7-10

60-6230-010 Figaro™ Mix F1

Double and semi-double 6-7 cm flowers. A very popular strain with growers, they will bloom in 70 days from sowing.

Height (cm): 35-45 Spreading (cm): 25-30

1 pkg 50 s/p 7.89 \$

DAHLIA - Dahlia x hybrida



☀️ 10-11 🌙 20-23 🪴 7-10

60-6255-010 Harlequin™ Mix F1

Lovely mixture of single colour and bicolor flowers for a powerful effect. The most compact and earliest of this type.

Filmcoat seed

Height (cm): 30 Spreading (cm): 15-25

1 pkg 50 s/p 7.89 \$

DAHLIA - Dahlia varialis



🪴 9-12 🌙 20-23 🪴 7-10

60-6248-010 Black Beauty™

This unique variety carries single 10 cm black flowers that fade to mahogany red. Ideal for containers, on its own or in a mix and in the garden or for mixed containers, it provides punch to any arrangements.

Height (cm): 35-45 Spreading (cm): 35

1 pkg 20 s/p 6.79 \$

☀️ 10-11 🌙 20-23 🪴 7-10

60-6260-010 Fireworks™ Mix

First ever striped mixture from seed, you'll get great contrasting colour on each flower. Due to the genetics, some solid flowers will appear in the mixture. Use it in mass planting for a great colour show.

Height (cm): 40 Spreading (cm): 40

1 pkg 20 s/p 6.79 \$





Dianthus Jolt™ Pink F1



Dianthus Rockin™ Red F1



Euphorbia Glitz F1



Blanket Flower Red Plume



Gaura Sparkle White



Gazania Big Kiss™ White Flame F1



Gazania Big Kiss™ Yellow Flame F1



Gazania Kiss™ Golden Flame F1

DIANTHUS - Dianthus interspecific ☀️

✂️ 🌸 16 🌿 18-21 🪴 3-5

61-3775-010 Jolt™ Pink F1

Interspecific dianthus with brightly colored and large, showy flower heads on strong stems that perform extremely well all summer long without setting seed. Jolt™ is the most heat tolerant. **Pelleted seed**

Height (cm): 40-50 Spreading (cm): 30-35

1 pkg 25 s/p 7.89 \$

✂️ 🌸 12-15 🌿 18-21 🪴 3-4

61-4156-010 Rockin™ Red F1

Slightly fragrant bright red serrated flowers.

Pelleted seed

Height (cm): 45-60 Spreading (cm): 25-30

1 pkg 25 s/p 7.89 \$

EUPHORBIA - Euphorbia graminea ☀️ 🌙

🌸 10-13 🌿 18-22 🪴 6

60-7439-010 Glitz F1

This new seed opportunity is now available and lets you enjoy an easy to grow and wonderful architectural plant! Heat tolerant, its medium vigor and good branching plays well with others in mixed containers.

Height (cm): 25-35 Spreading (cm): 30-46

1 pkg 20 s/p 10.09 \$

BLANKET FLOWER - Gaillardia pulchella ☀️

🌸 14-16 🌿 15 🪴 14-21

60-7666-010 Red Plume

Exceptional garden performance during the entire season. Double flowers are a nice deep red colour.

Height (cm): 40-60 Spreading (cm): 30

1 pkg 60 s/p 3.59 \$

GAURA - Gaura lindheimeri ☀️ 🌙

🌸 12-13 🌿 18-20 🪴 5-6

60-7779-010 Sparkle White

All America and Fleuroselect winner, this little star sparkles in your garden! Sparkle White is a great summer performer that adds a touch of airiness to a border, in mass planting and patio containers. This first year flowering perennial in zone 5b presents earlier with a more uniform flowering. Thanks to its better branching habit, long panicles of 3.5 cm starry white flowers decorate the garden until fall.

Height (cm): 30-60 Spreading (cm): 30-51

1 pkg 20 s/p 6.79 \$

GAZANIA - Gazania rigens ☀️

🌸 13-15 🌿 21 🪴 10-14

Big Kiss™ F1 series

Why use Big Kiss™? For its larger flowers that remain open longer and quickly fill containers and garden beds with brightly coloured 10 cm flowers. It is normal for the flowers to grow smaller during hot summer days, but they will get bigger again when the nights are cooler.

60-7825-010 Big Kiss™ White Flame F1

Unique creamy white flowers with a rose centre.

60-7826-010 Big Kiss™ Yellow Flame F1

Unique bright yellow flowers, with a red center.

Height (cm): 25-30 Spreading (cm): 25-30

1 pkg 15 s/p 6.79 \$

🌸 13-15 🌿 21 🪴 10-14

60-7862-010 Kiss™ Golden Flame F1

This variety bears numerous, brilliant orange flowers streaked with red that love heat and endure drought.

Height (cm): 20-25 Spreading (cm): 20-25

1 pkg 15 s/p 4.59 \$





Baby's Breath Covent Garden White



Earthwalker Sunflower



Lemon Queen Sunflower



Gazania New Day® Clear Orange F1



Gomphrena Ping Pong Purple



Concert Bell F1 Sunflower



Chocolat Cherry Sunflower

GAZANIA - Gazania splendens



🌸 13-14 🌿 21 🪴 10-14

60-7874-010 New Day® Clear Orange F1

Bred to develop larger flowers on shorter peduncles, it carries bright orange flowers with no dark central ring. You will appreciate this drought-tolerant plant for its excellent performance in patio containers and hanging baskets, as well as a garden edging or groundcover plant. **Pelleted seed**

Height (cm): 20-25 Spreading (cm): 15-20

1 pkg 15 s/p 4.59 \$

GOMPHRENA - Gomphrena globosa



✂️ 🌸 10-12 🌿 21-24 🪴 18-20

60-8838-010 Ping Pong Purple

Ping Pong Purple delivers an explosion of colour. It will add height and dimensions, terrific as a cut flower. Easy production, drought tolerance, and few maintenance requirements. Ideal for containers and mass planting.

Height (cm): 40-50 Spreading (cm): 20-25

1 pkg 25 s/p 4.59 \$

BABY'S BREATH - Gypsophila elegans



✂️ 🌸 9-10 🌿 21 🪴 10-15

60-9259-010 Covent Garden White

Large, pure white flowers. Ideal for cut flowers.

Height (cm): 45-60 Spreading (cm): 30-40

1 pkg 250 s/p 3.59 \$

SUNFLOWER - Helianthus annuus



🪴 ✂️ 🌸 11 🌿 16-18 🪴 7-14

61-8802-010 Lemon Queen

'Lemon Queen' produces sunflowers with light lemon-yellow petals with a brown centre. Lemon Queen is beautiful as background in borders and makes an excellent cut flower. These sunflowers grow to a height of 150 cm to 225 cm. Great plant that attract pollinators.

Height (cm): 150-225

1 pkg 50 s/p 4.59 \$

🪴 ✂️ 🌸 11 🌿 16-18 🪴 7-14

61-8810-010 Concert Bell F1

Concert Bell offers a unique floral presentation with several clusters of 10 to 12 flowers on a single upright stem. This variety has beautiful golden yellow flowers that grow to a height of 150 cm to 180 cm. Used as a cut flower, it forms an instant bouquet ready to use from a single cut. Concert Bell has been tested during one year in adverse weather conditions and has proven to be durable and robust, even in heavy storms and winds.

Height (cm): 150-180

1 pkg 30 s/p 6.79 \$

SUNFLOWER - Helianthus annuus



🪴 ✂️ 🌸 9-10 🌿 16-18 🪴 7-14

61-8816-010 Chocolat Cherry

Chocolate Cherry' sunflowers have dark chocolate centers surrounded by burgundy brown petals. The plant can grow from 175 cm to 225 cm tall with long flower stems, making this variety an excellent cut flower. "Chocolate Cherry" is a standout variety in the landscape and is excellent for pollinator gardens.

Height (cm): 175-225

1 pkg 50 s/p 4.59 \$

🪴 ✂️ 🌸 9-10 🌿 16-18 🪴 7-14

61-8826-010 Earthwalker

Earthwalker Sunflower grows in height from 150 cm to 225 cm with a flower in warm shades of orange, copper brown, mahogany and rusty red. Excellent for cut flowers and provides pollen and nectar for pollinators. Once the flowers are spent, leave the seeds for granivorous birds.

Height (cm): 150-225

1 pkg 50 s/p 4.59 \$





Sunflower Smiley™ F1



Sunflower Suntastic Golden F1



Sunflower Pacino® Gold



Sunflower Mammoth Russian

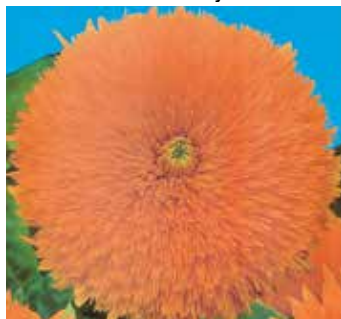

Sunflower Double Santa Fe



Sunflower Ring of Fire



Sunflower King Kong F1



Sunflower Autumn Beauty Mix



Sunflower Soraya

SUNFLOWER - Helianthus annuus

8 16-18 7-14

61-8803-010 Smiley™ F1

A dwarf and well-branched sunflower, perfect for a container. The flower is pollen-free and has a rich yellow colour. Its broad petals keep an excellent shape without curling.

Height (cm): 30-40 Spreading (cm): 20-30

1 pkg 30 s/p 6.79 \$

8-10 16-18 7-14

61-8822-010 Pacino® Gold

Very showy dwarf sunflower, with a better branching habit and more 10-12 cm yellow flowers with a brown center.

Height (cm): 30-40 Spreading (cm): 30

1 pkg 50 s/p 5.69 \$

9-10 16-18 7-14

61-8812-010 Suntastic Golden F1

The new reference of dwarf sunflower and the smallest on the market. Plant is very floriferous producing several waves of 12-15 cm flowers, up to 3 waves of 5-8 flowers, for a total up to 20 flowers per plant! Around 65 days from sowing to flowering.

Height (cm): 30-50 Spreading (cm): 30-40

1 pkg 20 s/p 7.89 \$

SUNFLOWER - Helianthus annuus

10-14 16-18 7-14

61-8833-010 Mammoth Russian

A large seeded type, with simple yellow flowers.

Height (cm): 300 Spreading (cm): 40-50

1 pkg 50 s/p 4.59 \$

9-11 16-18 7-14

61-8834-010 Double Santa Fe

It's a wonderful improvement over existing double flower varieties, for the quality and quantity of the flowers. Always a delight for a child's garden and a great cut flower too, as the bold, double, orange yellow flowers cheer up any room!

Height (cm): 150 Spreading (cm): 40

1 pkg 50 s/p 4.59 \$

10-12 16-18 7-14

61-8845-010 Soraya

Soraya is a branching type, with 10-15 cm distinct orange flowers, contrary to most sunflowers, which are golden yellow. Eye-catching in the garden, it is also superb in floral arrangements, yielding up to 20-25 stems per plant.

Height (cm): 180 Spreading (cm): 40

1 pkg 50 s/p 4.59 \$

SUNFLOWER - Helianthus annuus

10-12 16-18 7-14

61-8847-010 Ring of Fire

With its 12 cm, golden and red petals surrounding the chocolate brown center, Ring of Fire stands out in a crowd of plain gold or yellow flowers. Though it blooms later, possibly requiring 120 days, its late season display is often just what the garden needs for a fresh look.

Height (cm): 130-150 Spreading (cm): 40

1 pkg 50 s/p 4.59 \$

10-11 16-18 7-14

61-8848-010 King Kong F1

You want a true giant sunflower? Go for King Kong! It is a real monster, growing to 5 meters (16 feet) tall, is great fun for children and birds love it too, because of the mass of seeds.

Height (cm): 500 Spreading (cm): 40-50

1 pkg 25 s/p 4.59 \$

9-11 16-18 7-14

61-8860-010 Autumn Beauty Mix

This taller, branching sunflower variety produces red, yellow, gold, orange and burgundy flowers. It will bloom from midsummer through fall. It is a great pollinator plants. Stunning in mass planting!

Height (cm): 150-225 Spreading (cm): 40

1 pkg 50 s/p 4.59 \$



Morning glory
Carnaval de Venise



Morning glory Lazy Luxe



Morning glory Heavenly Blue



Morning glory Crimson Rambler



Impatiens Beacon™
Mix Red and White F1



Impatiens Beacon™
Select Mix F1



Strawflower
Monstrosium Mix



ING Florific® Sweet Orange F1

NEW GUINEA IMPATIENS -
Impatiens hawkeri



🌸 12-14 📏 22-24 🪴 6-8

61-0227-010 Florific® Sweet Orange F1

Uniquely bicolor flowers in shades of light salmon to deep orange. With resistance to impatiens downy mildew, it is the perfect alternative for shade gardens and will provide reliable, bright color in the garden all season long.

Height (cm): 20-30 Spreading (cm): 25-30

1 pkg 15 s/p 6.79 \$

IMPATIENS - Impatiens walleriana



🌸 9-12 📏 20-25 🪴 3-5

Beacon™ F1 series

Bring back the Impatiens walleriana into your with this new, highly resistant to mildew, series. Beacon™ Impatiens has a high resistance to Plasmopara obducens, which causes impatiens mildew. For more information, visit beaconimpatiens.com.

Filmcoat seed

61-0300-010 Beacon™ Mix Red and White F1

Mix of the red and the white.

61-0310-010 Beacon™ Select Mix F1

Height (cm): 35-45 Spreading (cm): 30-35

1 pkg 30 s/p 6.79 \$

MORNING GLORY - Ipomoea purpurea



🌸 12 📏 18-20 🪴 10-16

60-8480-010 Carnaval de Venise

Spectacular and colourful, this easy to grow climber has extraordinary striped white and red or white and blue flowers on heart-shaped leaves.

Height (cm): 160-180 Spreading (cm): 20-30

1 pkg 40 s/p 4.59 \$

🌸 12 📏 18-20 🪴 10-16

60-8490-010 Lazy Luxe

Lazy Luxe is a new luxurious mixture of 10 sparkling morning glory colours. It creates each morning, a dazzling display of delicate flowers in different colours from clear white to violet and rosy-red

Height (cm): 160-180 Spreading (cm): 20-30

1 pkg 40 s/p 4.59 \$

MORNING GLORY - Ipomoea tricolor



🌸 12 📏 18-20 🪴 10-16

60-8491-010 Heavenly Blue

'Heavenly Blue' has been the most popular variety of Morning Glory. This vigorous and showy climbing vine produces a profusion of trumpet-shaped, sky blue flowers with a creamy white throat and deep green, heart-shaped leaves.

Height (cm): 300 Spreading (cm): 20-30

1 pkg 40 s/p 3.59 \$

MORNING GLORY - Ipomoea purpurea



🌸 12 📏 18-20 🪴 10-16

60-8496-010 Crimson Rambler

Crimson Rambler displays large, deep red flowers with a white throat. This wonderful climber that loves warm and tropical conditions, is ideal to decorate a pergola or a fence or just to ramble through shrubs.

Height (cm): 300 Spreading (cm): 20-30

1 pkg 40 s/p 4.59 \$

STRAWFLOWER - Helichrysum bracteatum



✂️ 🌸 12-13 📏 18-23 🪴 7-14

60-9470-010 Monstrosium Mix

Large, 5 cm flowers on long stems in 5 fiery colours: crimson, bronze, yellow, rose and white.

Height (cm): 60-90 Spreading (cm): 40-45

1 pkg 125 s/p 4.59 \$





Tree Mallow Silver Cup



Nemophila Baby Blue Eyes



Flax Rubrum



Sweet pea Spencer Mix



Sweet pea Mammoth Mix



Lobelia Riviera Mix



Lobelia Regatta White



Four O'Clock Jalapa Mix

SWEET PEA - *Lathyrus odoratus*



🌱 🌿 🌸 10-12 📏 12-18 🪴 10-20

61-5980-010 Mammoth Mix

For production of cut flowers.

Height (cm): 200 Spreading (cm): 15

1 pkg 100 s/p 5.69 \$

🌱 🌿 🌸 10-12 📏 12-18 🪴 10-20

61-5990-010 Spencer Mix

Direct sow sweet pea seeds directly as soon as possible to work in your garden. The vines grow 1.8 m to 2 m in height and will climb on a vertical trellis. The Spencer Extra Mix variety produces strongly scented flowers. Expect purple, blue, red, and pink colours. It will produce a lot of flowers from June to August. They also make excellent cut flowers.

Height (cm): 180-200 Spreading (cm): 15-30

1 pkg 100 s/p 5.69 \$

TREE MALLOW - *Lavatera trimestris*



🌱 🌿 🌸 12-13 📏 18-22 🪴 10-21

61-0965-010 Silver Cup

Abundant, large, 10 cm, glowing pink veined flowers on bushy plants.

Height (cm): 60 Spreading (cm): 30-45

1 pkg 50 s/p 3.59 \$

FLAX - *Linum grandiflorum*



🌱 🌿 🌸 6-8 📏 15-18 🪴 14-21

61-1046-010 Rubrum

It is one of the easiest, showiest and most beautiful annuals. Brilliant blood-red flowers, with a beautiful satin sheen, are flowering from early summer to fall. They can be sown indoors or, directly where they are to flower, in the spring. They prefer a light well-drained soil and a sunny position.

Height (cm): 40 Spreading (cm): 30

1 pkg 150 s/p 3.59 \$

LOBELIA - *Lobelia erinus compacta*



🌱 🌿 🌸 9-11 📏 21-22 🪴 5-10

61-1320-010 Riviera Mix

This very early variety flower at least two weeks before other Lobelia varieties.

Multipellet seeds

Height (cm): 15 Spreading (cm): 20

1 pkg 20 s/p 3.59 \$

LOBELIA - *Lobelia erinus pendula*



🌱 🌿 🌸 12-15 📏 21-22 🪴 5-10

Regatta series

Regatta series flowers one month earlier and it is less likely to bare from the centre.

Multipellet seeds

61-1359-010 Regatta White

Height (cm): 15-20 Spreading (cm): 25-30

1 pkg 20 s/p 3.59 \$

FOUR O'CLOCK - *Mirabilis jalapa*



🌱 🌿 🌸 12-14 📏 20 🪴 10

61-6250-010 Jalapa Mix

In the Malay Archipelago, Four O'Clocks are said to be so habitual in their opening time that they are planted to serve as house clocks! Very popular variety, with one color or bicolored.

Height (cm): 50 Spreading (cm): 60

1 pkg 40 s/p 3.59 \$

NEMOPHILA - *Nemophila insignis*



🌱 🌿 🌸 6-8 📏 12 🪴 7-14

61-3011-010 Baby Blue Eyes

A delightful California wildflower covered with charming, 2.5 cm, sky-blue flowers with eyes. Pleasantly fragrant at night. Good for problem areas.

Height (cm): 15 Spreading (cm): 10

1 pkg 250 s/p 3.59 \$



Flowering Tobacco Saratoga™ Mix F1



Flowering Tobacco Only The Lonely



Shiso Nankinensis



Cape Daisy Akila® Daisy White F1



Cape Daisy Akila® Grand Canyon Mix F1



Poppy Ladybird



Ptilotus Matilda

FLOWERING TOBACCO - *Nicotiana glauca* ☀️ 🌞 🌙 🌛

🌸 9-11 📏 21-24 🪴 3-5

61-3110-010 Saratoga™ Mix F1

Saratoga™ produces bushy round plants with eye-catching, trumpet-shaped flowers. Use it in patio pots and you'll see hummingbirds appear. **Pelleted seed**
Height (cm): 40-50 Spreading (cm): 25-30

1 pkg 30 s/p 3.59 \$

FLOWERING TOBACCO - *Nicotiana glauca* ☀️ 🌞 🌙 🌛

🌸 13-14 📏 21-24 🪴 7-12

61-3189-010 Only The Lonely

Plants produce white drooping flowers that have a most pleasant scent. Popular for massing in large beds.
Height (cm): 150 Spreading (cm): 45

1 pkg 100 s/p 3.59 \$

CAPE DAISY - *Osteospermum ecklonis* ☀️ 🌞

🌸 14-16 📏 18-20 🪴 7-10

Akila® F1 series

Produces a more compact plant than the Asti series. Ideal series for high density production. Excellent garden performance.

61-4513-010 Akila® Daisy White F1

All America Selections and Fleuroselect winner, it is the first osteospermum covered with white flowers and yellow eye.

61-4515-010 Akila® Grand Canyon Mix F1

It is the first multicolor segregating mix which includes popular colors as found in cutting varieties: yellow, rose-reds, purple, lavender, creams and whites.

Height (cm): 25-40 Spreading (cm): 40-50

1 pkg 10 s/p 10.09 \$

POPPY - *Papaver commutatum* ☀️ 🌞

🌸 14 📏 15-18 🪴 14-21

61-4716-010 Ladybird

This charming dazzling red with black blotch poppy is easy to grow. It can be sown directly in the garden and it offers a spectacular flowering from July.

Height (cm): 30-40 Spreading (cm): 15-20

1 pkg 125 s/p 4.59 \$

SHISO - *Perilla frutescens* ☀️ 🌞 🌙 🌛

🌸 8-10 📏 20 🪴 7-14

61-6000-010 Nankinensis

Shiso, also called Chinese basil or beefsteak plant, is an ornamental and edible plant. Cultivated for the beauty of its foliage (flowers are also edible). The aroma of the leaves is between anise, lemon balm and pepper with a hint of cinnamon reminding a minty basil. It can be used raw to flavour salads and vegetables, or cooked to enhance fish and rice.

Height (cm): 40-60 Spreading (cm): 30

1 pkg 500 s/p 4.59 \$

PTILOTUS - *Ptilotus exaltatus* ☀️ 🌞

🌸 12-20 📏 24-26 🪴 5-7

61-4841-010 Matilda

Unique flower for cut flowers. Matilda will, without a doubt, be the center of attention in your arrangements. Great tolerance to heat and weather, ideal variety for sunny gardens.

Height (cm): 65

1 pkg 10 s/p 7.89 \$



Geranium Quantum™ Red F1



Geranium Maverick™ Appleblossom F1



Geranium Maverick™ Salmon F1



Geranium Maverick™ Pink F1



Geranium Maverick™ Red F1



Geranium Maverick™ Star F1



Geranium Maverick™ White F1



Geranium Pinto™ Premium White to Rose F1



Geranium BullsEye™ Mix F1



Geranium BullsEye™ Red F1



Geranium lierre Reach Out™ Mix F1

GERANIUM-IVY - Pelargonium peltatum ☀️

🌸 14-15 🌿 18-20 🪴 5-10

60-8140-010 Reach Out™ Mix F1

The blend of single flower hybrids. More compact and earlier than the Summer Showers variety. Offers complete coverage of flowers throughout the plant.

Height (cm): 15-20 Spreading (cm): 25-30

1 pkg 15 s/p 7.89 \$

GERANIUM - Pelargonium x hortorum ☀️

🌸 13-15 🌿 23 🪴 5-7

BullsEye™ F1 series

This fantastic series wears unique rich chocolate foliage edged in light green creating a beautiful contrast to the large 10 to 13-cm flower heads. This eye-catching variety works well alone, in garden or in mixed containers where the foliage provides added interest.

60-8116-010 BullsEye™ Red F1

60-8110-010 BullsEye™ Mix F1

Height (cm): 35-40 Spreading (cm): 28-35

1 pkg 15 s/p 7.89 \$

GERANIUM - Pelargonium x hortorum ☀️

🌸 14-15 🌿 23 🪴 5-7

Maverick F1 series

Considered as 'the reference' in pelargoniums by professional growers, they are profuse bloomers and carry large, round flower heads on attractive well-zoned foliage. Mavericks pelargoniums are spectacular in any container they are also beautiful garden performers.

60-8000-010 Maverick™ Appleblossom F1

60-8004-010 Maverick™ Salmon F1

60-8005-010 Maverick™ Pink F1

60-8006-010 Maverick™ Red F1

60-8007-010 Maverick™ Star F1

60-8009-010 Maverick™ White F1

Height (cm): 35-40 Spreading (cm): 30-35

1 pkg 15 s/p 7.89 \$

GERANIUM - Pelargonium x hortorum ☀️

🌸 14-15 🌿 23 🪴 5-7

60-8035-010 Pinto™ Premium White to Rose F1

All America and Fleuroselect Winner, the flower coloration of white changing to rose is unique wearing numerous 12.5 to 15 cm blooms. Full and dense plants have well-branched stems sporting leaves with beautiful dark green zone coloration.

Height (cm): 30-40 Spreading (cm): 30-35

1 pkg 15 s/p 7.89 \$

🌸 15-16 🌿 23 🪴 5-7

60-8046-010 Quantum™ Red F1

A unique product displaying attractive star-shaped flowers. Has an outstanding heat tolerance.

Height (cm): 30-40 Spreading (cm): 30-40

1 pkg 15 s/p, 7.89 \$



Petchoa Caliburst™ Yellow F1



Petunia Double Cascade Mix F1



Petunia Picobella™ Mix F1



Petunia Wave® Purple Improved F1



Petunia Wave® Purple Classic F1



Petunia Wave® Carmine Velour F1



Petunia Daddy® Mix F1



Petunia Limbo *GP* Blue F1



Petunia Limbo *GP* Red F1



Petunia Limbo *GP* White F1



Petunia Limbo *GP* Full Mix F1

PETCHOA - Petunia sp. x Calibrachoa sp. ☀️🌙

🌸 11-14 📏 20-25 🪴 7-10

60-2112-010 Caliburst™ Yellow F1

Caliburst™, the first petchoa by seed! The result of hybridization between petunia and calibrachoa. We find the vibrant colour of calibrachoa with the cold hardiness and short-day flowering of Wave® petunias, which will facilitate the success of sowing, it's the perfect match. Caliburst™ behaves like a vegetative variety, with the flexibility of seed varieties.. **Pelleted seed**

Height (cm): 15-25 Spreading (cm): 50-70

1 pkg 20 s/p 11.09 \$

PETUNIA - Petunia grandiflora ☀️🌙

🌸 10-12 📏 22-24 🪴 7-14

61-5230-010 Double Cascade Mix F1

Always popular, the mix of the Double Cascade Series shows huge, 10 cm, double flowers. They look wonderful in flower boxes or patio containers, in sunny areas. You'll get the best results using pots that are 13 cm or larger.

Pelleted seed

Height (cm): 25-40 Spreading (cm): 20-30

1 pkg 50 s/p 7.89 \$

🌸 9-11 📏 22-24 🪴 7-12

61-5310-010 Daddy® Mix F1

Superb mixture, producing large-veined flowers in shades of pink, blue and plum.

Pelleted seed

Height (cm): 25-36 Spreading (cm): 25-30

1 pkg 85 s/p 4.59 \$

PETUNIA - Petunia grandiflora ☀️🌙

🌸 10-12 📏 18-20 🪴 7-12

Limbo *GP* F1 series

The next generation of Limbo is indicated as *GP* for Garden Performance. Plants remain dwarfed with great garden performance.

Pelleted seed

61-5283-010 Limbo *GP* White F1

61-5290-010 Limbo *GP* Full Mix F1

61-5291-010 Limbo *GP* Blue F1

61-5296-010 Limbo *GP* Red F1

Height (cm): 15-20 Spreading (cm): 20-25

1 pkg 50 s/p 5.69 \$

PETUNIA - Petunia milliflora ☀️🌙

🌸 8-10 📏 22-24 🪴 7-10

61-5420-010 Picobella™ Mix F1

Picobella™ produces an abundance of 4-5 cm small flowers on carefree, early flowering, more compact plants than Shoc Wave® series. Self-cleaning, you do not have to remove dead flowers. Just enjoy the beauty of this winner!

Pelleted seed

Height (cm): 20-25 Spreading (cm): 20-25

1 pkg 50 s/p 5.69 \$

PETUNIA - TRAILING - Petunia x hybrida ☀️🌙

🌸 12-16 📏 22-24 🪴 7-12

Wave® F1 series

The spectacular and very popular Wave® series will bloom until autumn without being cut back. Performs well in heat and will tolerate cooler conditions if well fed and well-watered.

Pelleted seed

61-5442-010 Wave® Purple Improved F1

Purple Wave® Improved offers the same garden performance and flower color, but flowers faster and earlier than the original, on shorter stems.

61-5444-010 Wave® Carmine Velour F1

All-America Selections winner. The flowers are of an intense cherry carmine colour. Vigorous and very good spread. Good performers until cold weather.

61-5450-010 Wave® Purple Classic F1

Plants longer than Wave® Purple Imp.

Height (cm): 13-18 Spreading (cm): 90-120

1 pkg 20 s/p 11.09 \$





Petunia Easy Wave® Red Velour F1



Petunia Easy Wave® Burgundy Velour F1



Petunia Easy Wave® Blue F1



Petunia Shock Wave® Deep Purple F1



Petunia Shock Wave® Purple Tie Dye F1



Petunia Easy Wave® Red F1



Petunia Easy Wave® Silver F1



Petunia Shock Wave® Denim F1



Petunia Shock Wave® Red F1



Petunia Easy Wave® Pink Passion F1

PETUNIA - TRAILING - Petunia x hybrida ☀️🌙

🌸 10-12 📏 22-24 🪄 7-12

Easy Wave® F1 series

Growing a little more mounded, with more spread control than the Wave® series, Easy Wave® Petunias are ideal for landscape garden beds and adapt well to baskets and containers. Blooming freely all season long, they tolerate both heat and cooler conditions.

Pelleted seed

61-5465-010 Easy Wave® Pink Passion F1

61-5466-010 Easy Wave® Silver F1

61-5472-010 Easy Wave® Blue F1

61-5476-010 Easy Wave® Red F1

Height (cm): 15-30 Spreading (cm): 75-100

1 pkg 20 s/p

11.09 \$

PETUNIA - TRAILING - Petunia x hybrida ☀️🌙

🌸 10-12 📏 22-24 🪄 7-12

Easy Wave® Velour F1 series

Distinct category of Easy Wave® petunia ! Each bloom has velvety undertones and slightly darker throat which adds a textural, multi-dimensional look and brings new depth to your containers.

Pelleted seed

61-5468-010 Easy Wave® Burgundy Velour F1

Deep cabernet with velvet undertones. Deeper colour at throat.

61-5469-010 Easy Wave® Red Velour F1

True blood red colour.

Height (cm): 15-30 Spreading (cm): 75-100

1 pkg 20 s/p

11.09 \$

PETUNIA - TRAILING - Petunia x hybrida ☀️🌙

🌸 9-12 📏 22-24 🪄 7-12

Shock Wave® F1 series

Looking like Calibrachoa from seeds, Shock Wave® is the first spreading petunia series displaying small 4-5 cm flowers. Outstanding for hanging baskets, it is also an excellent choice for containers and garden ground cover. Easy to grow, very floriferous and self-cleaning, they offer continuous colour.

Pelleted seed

61-5261-010 Shock Wave® Denim F1

Blue-purple flowers changing to blue-lavender in high light and hot conditions.

61-5266-010 Shock Wave® Red F1

The only small-flowered spreading petunia from seeds now has a red colour in its selection.

61-5278-010 Shock Wave® Purple Tie Dye F1

61-5269-010 Shock Wave® Deep Purple F1

Height (cm): 18-25 Spreading (cm): 50-75

1 pkg 20 s/p

11.09 \$



Petunia Tidal Wave® Silver F1



Petunia Tidal Wave® Red Velour F1



Petunia Tickled™ Pink F1



Petunia Evening Scentsation™ F1



California Blue Bell



Phlox Popstars™ Mix F1

PETUNIA - TRAILING - Petunia x hybrida ☀️

🌸 12-16 🌿 22-24 🪴 7-12

Tidal Wave® F1 series

Tidal Wave® petunias are the tallest of the Wave® family and bloom over and over all season long and recover quickly, even after hard rains. Tidal Wave is an excellent landscape performer, covering a large area quickly and beautifully.

Pelleted seed

61-5491-010 Tidal Wave® Silver F1

Covered with silvery, lavender flowers with dark purple veins, Tidal Wave® has been awarded by both All-America Selection and Fleuroselect, for its terrific flower power.

61-5496-010 Tidal Wave® Red Velour F1

2015 AAS Winner Tidal Wave®Velour Red shows gorgeous deep red velvety blooms that don't fade, even in the heat of summer.

Height (cm): 45-55 Spreading (cm): 75-150

1 pkg 20 s/p 11.09 \$

PETUNIA - TRAILING - Petunia x hybrida ☀️

🌸 10 🌿 22-24 🪴 7-12

61-5521-010 Evening Scentsation™ F1

Evening Scentsation™ received an All America Selection award for its fragrance and its flower's stunning colour. It is one of the most beautiful blue petunias with a nice mounding and spreading habit ever seen. Its fragrance has notes of hyacinth, honey and rose. **Pelleted seed**

Height (cm): 12.5-20 Spreading (cm): 75-90

1 pkg 20 s/p 10.09 \$

🌸 12-16 🌿 22-24 🪴 7-12

61-5580-010 Tickled™ Pink™ F1

Petunia with a climbing habit .Very strongly scented, it produces a profusion of deep rose almost purple flowers. It is also ideal for production in hanging basket.

Pelleted seed

Height (cm): 150-200 Spreading (cm): 175

1 pkg 20 s/p 10.09 \$

CALIFORNIA BLUE BELL - Phacelia campanularia ☀️

🌸 11-12 🌿 18 🪴 12-30

61-5600-010 California Bleu Bell

One of the prettiest annuals, with delicate, bell-shaped flowers of vivid gentian blue with white anthers. Very pretty in mass plantings.

Height (cm): 15-30 Spreading (cm): 7.5-15

1 pkg 300 s/p 3.59 \$

PHLOX - Phlox drummondii ☀️

🌸 9-11 🌿 20-22 🪴 3-5

61-5610-010 Popstars™ Mix F1

Popstar™ is a new hybrid, naturally dwarf and branched, that fills up with single bicoloured star-shaped flowers, making a real constellation.

Height (cm): 25-30 Spreading (cm): 35-40

1 pkg 50 s/p 10.09 \$



Gloriosa Daisy Cherry Brandy™



Gloriosa Daisy Autumn Colors



Gloriosa Daisy Sahara



Gloriosa Daisy Cappuccino



Gloriosa Daisy Prairie Sun



Salvia Summer Jewel™ Red

GLORIOSA DAISY - Rudbeckia hirta



14-16 22-24 8-14

61-7161-010 Cherry Brandy™

This stunning new colour makes Cherry Brandy a very unique rudbeckia. It produces masses of single, 10-12 cm flowers in shades of red, from bright sanguine to bicoloured, with deep red centers. It is heat tolerant, an excellent cut flower, superb in borders and flower beds.
Height (cm): 50-60 Spreading (cm): 40

1 pkg 50 s/p 7.89 \$

13-14 22-24 8-14

61-7166-010 Cappuccino

Floreselect Gold Medal, judges have been charmed by the beauty, the uniformity and the quality of these bicolored red and yellow, large flowers. Very floriferous, it is the first semi-tall rudbeckia showing these colors.
Height (cm): 45-50 Spreading (cm): 40

1 pkg 40 s/p 5.69 \$

GLORIOSA DAISY - Rudbeckia hirta



14-16 22-24 8-14

61-7165-010 Sahara

The heart-breaker of our trial garden, Sahara is a delightful mix of caramel, soft pink and red blooms on the same plant. Flowers are semi-double to fully double. It shows good heat tolerance and great for amateur cut flowers as well.

Height (cm): 40-60 Spreading (cm): 30-45

1 pkg 40 s/p 5.69 \$

14-16 22-24 8-14

61-7170-010 Autumn Colors

The vivid play of fall colours, bronze petals, red rings and rusty red centers, creates an attractive contrast with other yellow rudbeckias. The single, 12 cm flowers, on long stems, mix well with other bedding plants or ornamental grasses.

Pelleted seed
Height (cm): 70-80 Spreading (cm): 45

1 pkg 50 s/p 7.89 \$

GLORIOSA DAISY - Rudbeckia hirta



14-16 22-24 8-14

61-7172-010 Prairie Sun

The large flowers, with light yellow tips on golden petals that encircle a green center, make this variety a winner in any sunny garden location.

Pelleted seed

Height (cm): 75 Spreading (cm): 30-45

1 pkg 50 s/p 7.89 \$

SALVIA - Salvia coccinea



8-10 24 7-10

61-7506-010 Summer Jewel™ Red

Fantastic and carefree plant, with outstanding garden performance. Compact and well-branched plants produce generous bright red flower spikes, from spring to autumn. A real hummingbird magnet.

Height (cm): 45 Spreading (cm): 60

1 pkg 40 s/p 5.69 \$



Salvia Fairy Queen



Bacopa Bluetopia® F1



Salvia Vista™ Red



Salvia Victoria™ Bleu



Bacopa Pinktopia F1



Bacopa Snowtopia® F1



Black-Eyed Susan African Sunset Mix

SALVIA - *Salvia farinacea* ☀️🌙

✂️ 🌸 12-14 📏 24 🪴 5-10

61-7553-010 Fairy Queen

This salvia earned a Fleuroselect Gold Medal because of its unique appearance and its outstanding garden performance. A small white spot on each sapphire blue flower, that emerges from the bluish floral spikes.

Height (cm): 45-55 Spreading (cm): 40

1 pkg 50 s/p 4.59 \$

🌿 ✂️ 🌸 12-14 📏 24 🪴 5-7

61-7548-010 Victoria™ Bleu

Dwarf, free-flowering plants, with much sought-after violet blue spikes. Highly ornamental.

Height (cm): 45 Spreading (cm): 25-30

1 pkg 50 s/p 5.69 \$

SALVIA - *Salvia splendens* ☀️🌙

🌿 🌸 8-10 📏 24 🪴 8-12

61-7536-010 Vista™ Red

Improved Carabinier type, it is one week earlier, on a more compact plant with very dark foliage.

Height (cm): 25-30 Spreading (cm): 20-25

1 pkg 40 s/p 4.59 \$

BACOPA - *Sutera cordata* ☀️🌙

🌿 🌸 8-9 📏 20-23 🪴 4

A great idea to grow Bacopa from seed. This very popular plant combines perfectly with your potted arrangements. Its drooping habit and cascades of white, pink or blue flowers perform as well as the varieties grown from cuttings. **Multipellet seeds**

60-0814-010 Pinktopia F1

60-0819-010 Snowtopia®

60-0821-010 Bluetopia®

Height (cm): 15 Spreading (cm): 45-60

1 pkg 20 s/p 6.79 \$

BLACK-EYED SUSAN - *Thunbergia alata* ☀️🌙

🌿 🌸 8-9 📏 21-24 🪴 6-12

61-8376-010 African Sunset Mix

African Sunset shows fascinating flowers, ranging from deep brick red to soft cream. The richly-coloured dark eye, in the center of the flower, adds character to its beauty and warm colors to your hanging baskets, flower boxes or patio containers.

Height (cm): 200

1 pkg 20 s/p 6.79 \$





Marigold - French Fireball



Marigold - African Giant Crackerjack Mix



Marigold - French Bonanza™ Yellow



Marigold - French Bonanza™ Mix



Marigold - French Bonanza™ Deep Orange



Marigold - French Durango® Bolero



Marigold - African Marvel II™ Mix F1



Marigold - French Disco Mix



Marigold Starfire Mix

MARIGOLD - AFRICAN - Tagetes erecta



✂️ 8-9 📏 22 🪴 5-8

61-4295-010 Giant Crackerjack Mix

Full, double, primrose to bright orange. Blooms up to 15 cm across. Neat, bushy plants. Early flowering.

Height (cm): 90 Spreading (cm): 30-45

1 pkg 90 s/p 3.59 \$

✂️ 8-9 📏 22 🪴 5-8

61-4360-010 Marvel II™ Mix

Marvel flowers are tighter, offering a better resistance to inclement weather and diseases due to high humidity. 9-10 cm flowers.

Height (cm): 45 Spreading (cm): 25-30

1 pkg 50 s/p 11.09 \$

MARIGOLD - Tagetes signata



🪴 9-11 📏 22 🪴 10-14

61-4480-010 Starfire Mix

A mixture of distinct colours, a bushy plant with fine fragrant leaves, for beautiful flower beds of small flowers.

Height (cm): 30-40 Spreading (cm): 25-30

1 pkg 90 s/p 4.59 \$

MARIGOLD - FRENCH - Tagetes patula



🪴 6-8 📏 22 🪴 5-8

Bonanza™ series

This wonderful series presents double crested, 5-6 cm flowers. In the garden, the plants are excellent performers under a wide range of conditions and need no care. Always beautiful and easy to grow.

61-4310-010 Bonanza™ Mix

61-4312-010 Bonanza™ Yellow

Yellow double crested, 5-6 cm flowers.

61-4315-010 Bonanza™ Deep Orange

The deepest orange blooms for French Marigolds, with double crested, 5-6 cm flowers. In the garden.

Height (cm): 25-30 Spreading (cm): 15-20

1 pkg 90 s/p 3.59 \$

🪴 6-8 📏 22 🪴 5-8

61-4410-010 Disco Mix

Becoming more and more popular, because of the large single blooms, up to 5 cm, in the brightest of colours.

Height (cm): 20-30 Spreading (cm): 20

1 pkg 90 s/p 4.59 \$

MARIGOLD - FRENCH - Tagetes patula



🪴 6-8 📏 22 🪴 5-8

61-4327-010 Durango® Bolero

Anemone type orange golden spotted with red flowers. The fragrant flowers and scented foliage attract bees, is heat and frost tolerant with low maintenance. Remove dead flowers to encourage additional flower development.

Height (cm): 25-30 Spreading (cm): 15-20

1 pkg 90 s/p 3.59 \$

🪴 6-8 📏 22 🪴 5-8

61-4236-010 Fireball

Wonderful new breeding producing multicolour blooms on the same plant. Flowers change colour from golden yellow to orange, then to red. The process is slower in spring and will accelerate under warmer conditions.

Height (cm): 25-30 Spreading (cm): 15-20

1 pkg 50 s/p 6.79 \$



Nasturtium Alaska Mix



Nasturtium Whirlybird Mix



Nasturtium Princess Of India



Nasturtium Orchid Cream



Nasturtium Strawberry Cream



Nasturtium California Giants



Nasturtium Baby Rose



Nasturtium Jewel Of Africa Mix

NASTURTIIUM - Tropaeolum minus



8-9 13-18 7-14

60-2601-010 Baby Rose

Fleuroselect Gold Medal winner and AAS winner, Baby Rose is a compact dark foliage variety, ideal for containers and small gardens. Its compact habit means less "flower flopping" and stays above the foliage all season.

Height (cm): 15 Spreading (cm): 20

1 pkg 25 s/p 5.69 \$

8-10 13-18 7-14

60-2610-010 Alaska Mix

Most adapted for pot production with its small bicoloured foliage and its flowers that sit well above the leaves. Allow 11 to 12 weeks from sowing to flowering.

Height (cm): 25 Spreading (cm): 20

1 pkg 40 s/p 4.59 \$

8-10 13-18 7-14

60-2620-010 Whirlybird Mix

Large, spur less flowers that are upward facing and borne well above the foliage. The flowers and leaves are edible. Use them to add colour to and decorate your salads.

Height (cm): 30 Spreading (cm): 20

1 pkg 40 s/p 5.69 \$

NASTURTIIUM - Tropaeolum minus



8-9 13-18 7-14

60-2632-010 Strawberry Cream

A delicious mixture of primrose spotted and red flowers. The flowers are held above the foliage and can be picked as an edible decoration

Height (cm): 30 Spreading (cm): 20

1 pkg 25 s/p 5.69 \$

8-9 13-18 7-14

60-2635-010 Orchid Cream

An unusual Nasturtium with chameleon-like flowers! The colour changes from cream splashed with red to fully red. The final flower colour depends on the temperature.

Height (cm): 30 Spreading (cm): 20

1 pkg 25 s/p 5.69 \$

8-9 13-18 7-14

60-2636-010 Princess of India

This superb compact plant with dark foliage that contrasts nicely with its bright scarlet red flowers is well adapted for growth in poor soil. Its flowers are also wonderful to decorate a salad or a special dish.

Height (cm): 20-25 Spreading (cm): 20

1 pkg 40 s/p 5.69 \$

NASTURTIIUM - Tropaeolum majus



10-11 13-18 7-14

60-2680-010 Jewel Of Africa Mix

Jewel of Africa is the original climbing nasturtium with white striped and marbled variegated foliage. It produces an abundance of edible flowers in a full range of colours, including unusual strawberry red and bronze shades.

Height (cm): 200 Spreading (cm): 150

1 pkg 40 s/p 3.59 \$

11-12 13-18 7-14

60-2690-010 California Giants

Climbing or cascading mixture made up of single flowers in various colours.

Height (cm): 150 Spreading (cm): 60-90

1 pkg 40 s/p 3.59 \$

11-12 13-18 7-14

60-2674-010 Orange Troika

Variety with vibrant tangerine orange flowers all summer. Impressive in combination with the variegated leaves, semi-trailing plants wind themselves through the border and cascade beautifully over edges and from baskets.

Height (cm): 30 Spreading (cm): 100-150

1 pkg 40 s/p 5.69 \$



Pansy Cool Wave® Raspberry F1



Vinca Pacifica Xp Burgundy Halo



Verbena Finesse®



Pansy Cool Wave® Mix F1



Pansy Tasty™ Mix F1



Viola Admire® Maxi Mix



Viola Sorbet® Xp Delft Blue F1

VERBENA - *Verbena bonariensis*



🌱 🌿 🌸 12-14 📏 22-24 🪴 14-21

61-8987-010 Finesse®

Very showy in mass plantings, *Verbena bonariensis* wears purple flowers in umbels and is one of the best landscaping plants. Attracts butterflies.

Primed seed

Height (cm): 120 Spreading (cm): 45-60

1 pkg 50 s/p 6.79 \$

VIOLA - *Viola cornuta*



🌸 10-11 📏 18-21 🪴 7-10

61-9331-010 Sorbet® Xp Delft Blue F1

A Gold Medal winner with Old Dutch charm! Sorbet® XP Delft Blue has a unique, true blue colour, with a white face as beautiful and precious as the porcelain that lends its name.

Height (cm): 15-20 Spreading (cm): 15-20

1 pkg 50 s/p 4.59 \$

PANSY - *Viola wittrockiana*



🌸 8-9 📏 18-21 🪴 7-10

61-5100-010 Tasty™ Mix F1

Tasty™ is the best edible pansy variety. Specifically bred for taste and scent. Its large flowers have a mild sweet peppery taste. Can be grown in summer and in winter. A truly multifunctional variety.

Height (cm): 15-20 Spreading (cm): 20

1 pkg 40 s/p 6.79 \$

VINCA - *Vinca rosea*



🌸 12-14 📏 26 🪴 7-15

61-9140-010 Pacifica XP Burgundy Halo

«All America» winner. A burgundy halo surrounding a large white center makes a vivid contrast for this bicolor bloom, quite spectacular in a garden or patio containers. Heat and drought tolerant, it requires little water. Quite carefree and known as the sun's Impatiens.

Height (cm): 25-35 Spreading (cm): 15-20

1 pkg 30 s/p 4.59 \$

🌸 8-10 📏 18-21 🪴 7-10

61-9360-010 Admire® Maxi Mix F1

Spectacular variety producing 3 cm unique and bright colored flowers.

Primed seed

Height (cm): 16-20 Spreading (cm): 20

1 pkg 50 s/p 6.79 \$

🌸 10-11 📏 18-21 🪴 7-10

Cool Wave® F1 series

That spreading pansy with medium size flowers earns the right to wear the 'Wave®' brand name for its incredible performance as filler in mixed combos, in hanging baskets or as ground cover. Delivering easy spreading colour for fall, it is a good replacement for *Impatiens walleriana*.

Primed seed

61-5166-010 Cool Wave® Raspberry F1

61-5170-010 Cool Wave® Mix F1

Height (cm): 15-20 Spreading (cm): 60-75

1 pkg 20 s/p 7.89 \$



Zinnia Swizzle™ Cherry & Ivory F1



Zinnia Oklahoma Mix



Zinnia Come & Cut Again Mix



Zinnia Zinderella Mix



Zinnia Art Deco™



Zinnia Queeny Lime Orange



Zinnia Benary's Giant Mix



Zinnia Inca



Zinnia Zinderella Purple

ZINNIA - Zinnia elegans



8-10 20-22 7-10

61-9780-010 Art Deco™

You'll be charmed by this contrasting mix of shades of purple, light pink and lavender. The 10-12 cm, double flowers are very attractive in mass plantings, but don't forget to use them for fresh bouquets.

Height (cm): 90 Spreading (cm): 25-30

1 pkg 30 s/p 3.59 \$

8-10 20-22 7-10

61-9770-010 Come & Cut Again Mix

This is one of the most beautiful zinnia mixture discovered in our trial garden! Producing a rainbow of colors, these double flowers of all sizes are lovely in the garden and especially in a fresh bouquet. Cut as many as you like to induce more flowering, and this until the early frost.

Height (cm): 55 Spreading (cm): 20-25

1 pkg 30 s/p 4.59 \$

8-10 20-22 7-10

61-9787-010 Inca

This incredible variety displays large 10-12 cm, fully double, bright orange cactus flowers. Eye-catching in the garden, it is also very good for cutting.

Height (cm): 90 Spreading (cm): 50-60

1 pkg 30 s/p 3.59 \$

ZINNIA - Zinnia elegans



8-10 20-22 7-10

61-9750-010 Oklahoma Mix

Developed for cut flower production, this variety is wonderful in the garden and, if pinched, will produce up to 25 double 4 cm flowers on each plant. Also less susceptible to powdery mildew.

Height (cm): 75-90 Spreading (cm): 45

1 pkg 15 s/p 3.59 \$

8-10 21-24 7-10

61-9726-010 Swizzle™ Cherry & Ivory F1

Great garden performers. Stunning, large, bicoloured double flowers cover the full, bushy, easy care plants, which will be at their best in sunny conditions and dry soil. **Filmcoat seed**

Height (cm): 30-35 Spreading (cm): 25-30

1 pkg 15 s/p 6.79 \$

8-10 20-22 7-10

61-9774-010 Queeny Lime Orange

AAS 2018 winner for its unique colour which evolves dark coral/peach/orange to light peach with a dark centre as and as the flowers age.

Height (cm): 60-90 Spreading (cm): 45-50

1 pkg 30 s/p 6.79 \$

ZINNIA - Zinnia elegans



8-10 20-22 7-10

61-9781-010 Benary's Giants Mix

Huge blooms in a wide range of bright colours. Colors include: red, orange, pink, yellow, green and white.

Height (cm): 90 Spreading (cm): 30-40

1 pkg 50 s/p 10.09 \$

8-10 20-22 7-10

Zinderella series

Distinctive Scabiosa-flowered zinnia produced on long plants. Double 5 cm diameter flowers have dark eye centres and can have a vase life of up to 12 days.

61-9789-010 Zinderella Purple

Purple flowers with a dark eye.

61-9786-010 Zinderella Mix

This Zinderella Mixture is a blend of Lilac, Orange, Peach, Purple, Red and White

Height (cm): 60 Spreading (cm): 45-50

1 pkg 30 s/p 6.79 \$



Zinnia Zahara® Starlight Rose



Zinnia Zahara® Sunburst



Zinnia Zahara® Mix

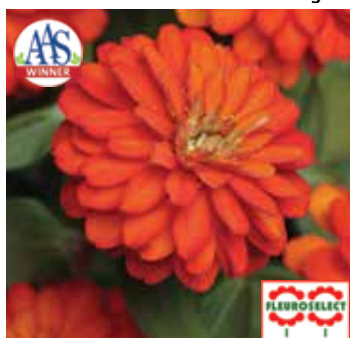

Zinnia Double Zahara™ Fire



Zinnia Double Zahara™ Raspberry Ripple



Zinnia Profusion Red Yellow Bicolore F1



Zinnia Profusion Double Yellow F1



Zinnia Profusion Double Hot Cherry F1



Zinnia Profusion Red F1

ZINNIA - Zinnia x hybrida



🌿 10-12 📏 25 🪴 5-10

Profusion F1 series

Profusion, one of the most rewarded series during the past few years. With its remarkably consistent performance, resistance to disease and abundance of stunning single flowers (5 cm), it's, with no doubt, a true winner. **Filmcoat seed**

61-9843-010 Profusion Red F1

61-9865-010 Profusion Red Yellow Bicolore F1

First to win AAS in 2020, FleuroSelect Gold and "Les Exceptionnelles" in 2021.

Height (cm): 35-45 Spreading (cm): 50-60

1 pkg 35 s/p 7.89 \$

🌿 10-12 📏 25 🪴 5-10

Double Profusion F1 series

Most popular series in its categories producing double flowers. Very tolerant to Powdery Mildew and Alternaria. **Filmcoat seed**

61-9851-010 Profusion Double Yellow F1

61-9858-010 Profusion Double Hot Cherry F1

All America and Fleuroselect winner, just the look of this splendid flowers will brighten your day.

Height (cm): 35-45 Spreading (cm): 50-60

1 pkg 35 s/p 7.89 \$

ZINNIA - Zinnia marylandica



✂️ 8-10 📏 20-23 🪴 5-10

Zahara® series

Few annuals top zinnias for durability in rugged garden conditions and speed of growth. This series is a breeding breakthrough, with remarkably consistent performance, abundance of stunningly beautiful, 5 cm flowers and tolerance to powdery mildew.

Filmcoat seed

61-9814-010 Zahara® Starlight Rose

This zinnia wears unique, large, single, rose-centered white flowers.

61-9810-010 Zahara® Mix

This mixture has large semi-double flowers, in shades of white, coral-pink, scarlet and the first clear yellow zinnia.

61-9818-010 Zahara® Sunburst

The flowers bursts open gold, followed by the appearance of a red stripe down the centre of each petal when temperature warms up.

Height (cm): 30-46 Spreading (cm): 30-46

1 pkg 35 s/p 7.89 \$

ZINNIA - Zinnia marylandica



🌿 8-10 📏 20-23 🪴 5-10

Double Zahara™ series

This fabulous series produces flamboyant, 6 cm, fully double flowers. Heat tolerant, sun loving annual, it blooms in about 8 to 10 weeks from sowing, on 25 cm, compact, disease resistant plants. **Filmcoat seed**

61-9824-010 Double Zahara™ Fire

Double deep orange flowers.

61-9829-010 Double Zahara™ Raspberry Ripple

Proclaimed among 'Les Exceptionnelles 2018' by the public and the experts, this zinnia deploys delightful rose and white flowers whose tint varies according to the climatic environment.

Height (cm): 40-50 Spreading (cm): 41-50

1 pkg 30 s/p 7.89 \$



BIENNIALS & PERENNIALS



Hollyhock Halo Mix



Yarrow Cassis



Columbine McKana Giants Mix



Hollyhock Fiesta Time



Milkweed Red Butterfly



Hollyhock Spring Celebrities™
Formula Mix



Bellflower Rapido Blue F1



Astilbe Rhapsody Mix



Delphinium Blue Butterfly

YARROW - *Achillea millefolium*



62-3048-010 - Cassis

Rewarded with a FleuroSelect Quality Mark for being a first year flowering *Achillea millefolium*, Cassis produces many stems of intense cherry pink coloured umbels.

Hardiness zone: 3 Height (cm): 60
Spreading (cm): 45

1 pkg 50 s/p 5.69 \$

HOLLYHOCK - *Alcea rosea*

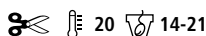

62-2240-010 - Halo Mix

Beauty of the classic English garden and ideal for adding height to borders, this mix is just incredible with its contrasting flower colours. **Biennial**

Hardiness zone: 3 Height (cm): 200
Spreading (cm): 30

1 pkg 30 s/p 6.79 \$

62-2255-010 - Fiesta Time

First year blooming from a January sowing, it produces elegant double cherry-pink flowers on compact plant that can be planted in a large container or used as a border plant. **Biennial**

Hardiness zone: 3 Height (cm): 100
Spreading (cm): 30-60

1 pkg 15 s/p 5.69 \$

HOLLYHOCK - *Alcea rosea*

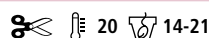

62-2260-010 Spring Celebrities™ Formula Mix

Aware that rust represents a serious problem in altheae, Spring Celebrities is a rust tolerant variety. Pretty unique, the compact plants wear semi-double to double flowers and are excellent for flowerbed borders or patio containers. **Biennial**

Hardiness zone: 3 Height (cm): 70
Spreading (cm): 30

1 pkg 20 s/p 10.09 \$

COLUMBINE - *Aquilegia x cultorum*

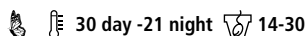

62-3680-010 - McKana Giants Mix

Mixture of 10 cm flowers in light shades.

Hardiness zone: 4 Height (cm): 80
Spreading (cm): 30-45

1 pkg 60 s/p 3.59 \$

MILKWEED - *Asclepias curassavica*

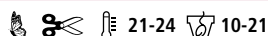

62-4356-010 - Red Butterfly

Asclepias curassavica. Attractive clusters of buds opening to scarlet-red and bright yellow flowers that will attract butterflies and many pollinators. This easy-care plant requires little attention. Tolerates poor soils. Ideal for introducing into naturalized areas and gardens for cut flowers. For flower arrangement, cut when the flowers are 2/3 open.

Hardiness zone: 5 Height (cm): 60-70
Spreading (cm): 30-60

1 pkg 100 s/p 5.69 \$

ASTILBE - *Astilbe arendsii*

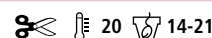

62-4510-010 - Rhapsody Mix

Perfect for landscapes and as cut flowers. Vigorous plants with long, slender plumes in intense shades of vibrant mixture colours. Needs vernalization for flower initiation. **Pelleted seed**

Hardiness zone: 3-4 Height (cm): 80
Spreading (cm): 13-20

1 pkg 25 s/p 10.09 \$

BELFLOWER - *Campanula carpatica*

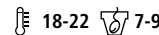

62-5215-010 - Rapido Blue F1

Rapido is a hybrid variety replacing the Clips Blue. More uniform, it will bloom the first year, 3 to 4 weeks earlier. Larger flowers than the non-hybrid Clips. A true improvement! **Pelleted seed**

Hardiness zone: 3 Height (cm): 13-18
Spreading (cm): 13-20

1 pkg 50 s/p 5.69 \$

DELPHINIUM - *Delphinium grandiflorum*

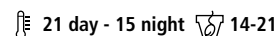

63-5201-010 - Blue Butterfly

Popular compact variety.

Hardiness zone: 3-4 Height (cm): 40-50
Spreading (cm): 30-45

1 pkg 100 s/p 4.59 \$



Digitalis Panther™ F1



Blanket flower Arizona Sun



Blanket flower Arizona Apricot



Blanket flower Arizona Red Shades



Gentian Lagodechiana Blue



Delphinium Cheer Blue F1



Coneflower PollyNation Yellow



Coneflower PollyNation Orange Red



Coneflower PollyNation Golden Summer Mix

DELPHINIUM - Delphinium grandiflorum



☞ 21 day - 15 night ☞ 14-21

63-5161-010 - Cheer Blue F1

Winner of an AAS and Fleuroselect 2020, in northern climates, they loved this compact delphinium covered with magnificent blue flowers. This variety has great vigor, excellent germination and is very easy to grow. Cheer's uniformity makes it ideal for creating beautiful landscaping borders. It offers an early flowering, which is prolonged until the beginning of summer, the gardeners of the North will be in delighted!

Hardiness zone: 3-4 Height (cm): 40 Spreading (cm): 25

1 pkg 20 s/p 7.89 \$

DIGITALIS - Digitalis x hybrida



☞ 15-18 ☞ 10-12

62-0446-010 - Panther™ F1

It will flower the first year without vernalization, early in the season with sterile flowers, making them more durable. The plant is strongly branched and produces several ears at a time without pinching. Great to attract pollinators. **Biennial. Pelleted seed**

Hardiness zone: 5 Height (cm): 45-55 Spreading (cm): 45

1 pkg 25 s/p 6.79 \$

BLANKET FLOWER - Gaillardia x grandiflora



☞ 22 ☞ 5-15

62-7722-010 - Arizona Sun

An All-America Selection and Fleuroselect winner, Arizona Sun is a wonderful variety that flowers the first year with no need of cold treatment. Earlier than Goblin, it stays in bloom until fall attracting butterflies in search of nectar. **Pelleted seed**

Hardiness zone: 3 Height (cm): 30 Spreading (cm): 25

1 pkg 75 s/p 7.89 \$

62-7724-010 - Arizona Apricot

An All America Selections winner its colour is spectacular. New and unique 7.5-8 cm single flowers have yellow edges that deepen to a rich apricot in the centre. First year blooming, this long free-flowering perennial blooms heavily without vernalization. Maintenance free and drought-tolerant.

Pelleted seed Hardiness zone: 3 Height (cm): 30 Spreading (cm): 25

1 pkg 75 s/p 7.89 \$

62-7736-010 - Arizona Red Shades

Offering the same performance in habit and in flower power as the highly acclaimed Arizona Sun, the deep crimson flowers of Arizona Red Shades literally cover the plant until the first frost. Can be grown as an annual without vernalization. A drought tolerant plant with outstanding garden performance.

Pelleted seed Hardiness zone: 3 Height (cm): 30 Spreading (cm): 25

1 pkg 75 s/p 7.89 \$

GENTIAN - Gentiana septemfida



☞ 21 ☞ 7-14

62-7921-010 Lagodechiana Blue

Ideal plants for grouping in the foreground of borders. Clear blue, trumpet-shaped flowers in July and August. Easy to cultivate.

Hardiness zone: 3 Height (cm): 20 Spreading (cm): 30-45

1 pkg 100 s/p 6.79 \$

CONEFLOWER - Echinacea purpurea



☞ 20-22 ☞ 10-14

PollyNation series

An Echinacea series from seed that will bloom the first year. This early series has large and vivid colour flowers. The plant is well branched, perfect for patio and garden containers. Excellent tolerance to heat and drought. Attracts bees and a wide range of insects.

63-7352-010 PollyNation Yellow

This variety has large early flowers of a bright yellow.

63-7354-010 PollyNation Orange Red

This variety has large early flowers of a bright red orange.

63-7353-010 PollyNation Golden Summer Mix Mix of Magenta, Orange Red, White, and Yellow.

Hardiness zone: 4 Height (cm): 60-70 Spreading (cm): 30-40

1 pkg 15 s/p 10.09 \$



Coneflower PowWow® Wild Berry



Coneflower Double Decker



Coneflower Paradiso



Coneflower Primadonna® White



Coneflower Primadonna® Deep Rose

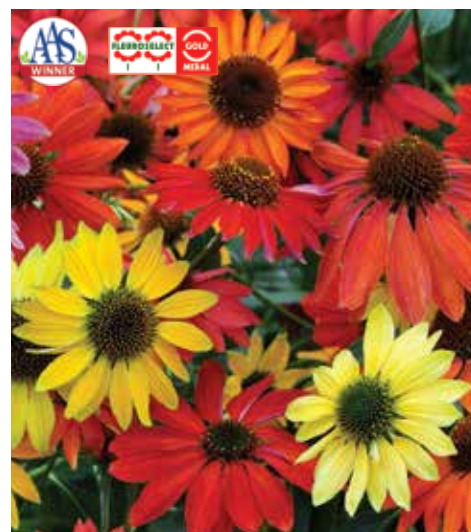

Coneflower Cheyenne Spirit F1

CONEFLOWER - Echinacea X hybrida



🌱 🌿 22-24 🌿 7-14

63-7360-010 Cheyenne Spirit F1

2013 All America Selections and Fleuroselect Winner, this stunning first-year flowering. A delightful mix of flower colors from rich purple, pink, red and orange tones to lighter yellows, creams and white. They offers a wide range of uses from the perennial border, in a mass landscape planting, in a butterfly garden or as a cut flower. Even during wind and rain, this compact plant does not topple over like many echinacea.

Hardiness zone: 4 Height (cm): 45-75 Spreading (cm): 25-50

1 pkg 15 s/p 10.09 \$

CONEFLOWER - Echinacea purpurea



🌱 🌿 22-24 🌿 7-14

63-7348-010 PowWow® Wild Berry

This All America Selections Winner is the first compact echinacea generated from seed to produce unique deep rose-purple flowers of 7 to 10 cm in diameter. This perennial will flower the first year early.

Hardiness zone: 4 Height (cm): 40-50 Spreading (cm): 30-40

1 pkg 25 s/p 7.89 \$

CONEFLOWER - Echinacea purpurea



🌱 🌿 22-24 🌿 7-14

63-7365-010 Double Decker

Really unique, it produces single purple rose flowers and the following year a very high percentage of reliable twins are produced on sturdy stems. Some flowers may even be fully double. It's like good wine improving from year to year! Flowers the second year from sowing.

Hardiness zone: 3 Height (cm): 60-90 Spreading (cm): 60-75

1 pkg 40 s/p 7.89 \$

🌱 🌿 20-22 🌿 10-14

63-7387-010 Primadonna® White

White flower version of "Primadonna Rose", it flowers the second year from sowing and is adorned with large round flowers from July to September. This perennial has durable flower power and is also a cut flower that has a vase life of 7 to 12 days. Cold period treatment not necessary. **Primed seed**

Hardiness zone: 3 Height (cm): 70-80 Spreading (cm): 30-60

1 pkg 40 s/p 7.89 \$

CONEFLOWER - Echinacea purpurea



🌱 🌿 20-22 🌿 10-14

63-7388-010 Primadonna® Deep Rose

Thriving in hot and sunny locations, 'Primadonna' is in its glory from mid-summer till frost. An improved 'Magnus', the large 12-15 cm lavender rose daisy-like flowers are an ideal fresh or dried selection and they attract butterflies in the garden bed.

Primed seed Hardiness zone: 3 Height (cm): 70-80 Spreading (cm): 30-60

1 pkg 40 s/p 7.89 \$

🌱 🌿 20-22 🌿 7-14

63-7380-010 Paradiso

Paradiso is a colourful mixture of unique colours and species. You will get a long blooming period from July to October of the second year from sowing attracting hummingbirds in your flowerbed. Perennial.

Hardiness zone: 3 Height (cm): 60-80 Spreading (cm): 30-60

1 pkg 25 s/p 7.89 \$



Daisy Crazy Daisy



Kniphofia Flamenco Mix



Lupine Gallery® Mix



Lavender Chill-Out Blue



Sneezeweed Helena Red Shades



Money Plant Alba



Sweet Pea Pearl Mix



Rose mallow Luna™ Red F1



Baby's breath Snow Flake White

BABY'S BREATH - *Gypsophila paniculata* ☀️

🌱 ✂️ 📏 20-22 🍷 10-15

62-8489-010 Snowflake

Plants produce small white flowers of which 50% are double.

Hardiness zone: 4 Height (cm): 90

Spreading (cm): 40

1 pkg 180 s/p 4.59 \$

SNEEZEWEED - *Helenium autumnale* ☀️

🌱 ✂️ 📏 18-21 🍷 14-20

62-8666-010 Helena Red Shades

A first year flowering perennial, Helena produces countless small red daisy-like flowers on well-branched, upright stems in August and September. Cold weather treatment not required. It is also a superb cut flower that performs well in a vase.

Hardiness zone: 3 Height (cm): 120

Spreading (cm): 50-60

1 pkg 100 s/p 7.89 \$

ROSE MALLOW - *Hibiscus moscheutos* ☀️

🌱 📏 20-24 🍷 3-5

62-9186-010 Luna™ Red F1

First year flowering perennial, Luna is dramatic and impressive with many eye-catching 15-20 cm flowers. Heat loving plants, they flower under long day conditions, are hardy at -29°C and attract hummingbirds.

Hardiness zone: 5 Height (cm): 60-90

Spreading (cm): 60

1 pkg 10 s/p 10.09 \$

KNIPHOFIA - *Kniphofia uvaria* ☀️☀️

🌱 ✂️ 📏 18-22 🍷 14-20

63-9180-010 Flamenco Mix

This mixture produces large bottlebrush heads in a range of shades, including cream, yellow, orange and red. Drought tolerant, it is easy to grow in the garden as long as the soil is well drained. Its flower stems are wonderful for cutting. Attractive to hummingbirds.

Primed seed

Hardiness zone: 5 Height (cm): 80

Spreading (cm): 30-40

1 pkg 50 s/p 6.79 \$

SWEET PEA - *Lathyrus latifolius* ☀️☀️

✂️ 📏 12-18 🍷 14-21

63-0590-010 Pearl Mix

Lovely blooms in shades of red, pink and white.

Hardiness zone: 3 Height (cm): 200

Spreading (cm): 15

1 pkg 25 s/p 6.79 \$

DAISY - *Leucanthemum x superbum* ☀️

✂️ 📏 22-25 🍷 10-14

62-5809-010 Crazy Daisy

Add fun and beauty to your perennial garden with Crazy Daisy, the first medium tall chrysanthemum with a high percentage of fluffy double flowers.

Hardiness zone: 5 Height (cm): 60-70

Spreading (cm): 45-60

1 pkg 125 s/p 4.59 \$

MONEY PLANT - *Lunaria annua* ☀️☀️

✂️ 📏 18-20 🍷 10-14

62-0969-010 Alba

Especially valued for the decorative, large, flat, silvery seedpods. Pretty white flowers grow in loose spikes.

Attractive in mass plantings. **Biennial**

Hardiness zone: 4 Height (cm): 60-70

Spreading (cm): 30

1 pkg 30 s/p 5.69 \$

LUPINE - *Lupinus polyphyllus* ☀️☀️

✂️ 📏 15-20 🍷 14-21

63-2140-010 Gallery® Mix

A variety of compact lupine that contains a mixture of single colored dark blue, red, pink, yellow and white flowers.

Hardiness zone: 3 Height (cm): 50-60

Spreading (cm): 30-40

1 pkg 30 s/p 7.89 \$

LAVANDER - *Lavandula angustifolia* ☀️

🌱 📏 18-21 🍷 14-20

63-0961-010 Chill-Out Blue

Lavandula angustifolia flowers the first year without vernalization. The plant has a compact, well-branched habit and a deep, intense blue color. Pollinators will be attracted by its pleasant fragrance. **Primed seed**

Hardiness zone: 5 Height (cm): 25

1 pkg 25 s/p 7.89 \$



Mexican hat Red Midget



Musk mallow Braveheart



Poppy - Spanish Double Tangerine Gem™



Poppy - Oriental Fruit Punch™ Mix



Cinquefoil Fireball Mix



Beebalm Panorama Mix



Forget Me Not Blue



Chinese lantern var. franchetii

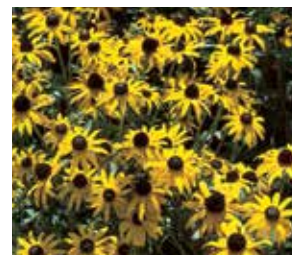

Coneflower Goldstrum

MUSK MALLOW - *Malva sylvestris*



✂️ 15-18 🪴 10-14

63-2988-010 Braveheart

Braveheart' boasts violet stripes that pinwheel out from the lilac centre of its beautiful flower. It reseeds itself easily.

Hardiness zone: 3 Height (cm): 150

Spreading (cm): 60

1 pkg 50 s/p 7.89 \$

BEEBALM - *Monarda didyma*



✂️ 20-22 🪴 14-21

63-3170-010 Panorama Mix

A mixture of shades of violet, crimson and pink. Lengthy blooming period in mid-summer. Aromatic, mint-scented foliage.

Hardiness zone: 3 Height (cm): 90

Spreading (cm): 30-45

1 pkg 50 s/p 3.59 \$

FORGET ME NOT - *Myosotis sylvatica*



🐛 ✂️ 18-21 🪴 8-14

62-1221-010 Blue

A splendid European strain of compact, ball-shaped plants, loaded with rich blue flowers with a creamy yellow eye that sit on top of the foliage. **Biennial**

Hardiness zone: 4 Height (cm): 25-45

Spreading (cm): 15-30

1 pkg 90 s/p 3.59 \$

POPPY - ORIENTAL - *Papaver orientale*



🐛 ✂️ 15-18 🪴 10-21

63-4160-010 Fruit Punch™ Mix

The large 12 cm ruffled blooms show off vibrant shades of colour that range from reds to hot pinks and even to shades of plum. These strong perennial plants are vigorous and resistant to various weather conditions.

Hardiness zone: 2 Height (cm): 60-75

Spreading (cm): 30

1 pkg 80 s/p 4.59 \$

POPPY - SPANISH - *Pavaver rupifragum*



🐛 ✂️ 15-18 🪴 7-14

63-4194-010 Double Tangerine Gem™

Magnificent double flowers. Perfect for pollinators.

Hardiness zone: 2 Height (cm): 60

Spreading (cm): 30

1 pkg 100 s/p 4.59 \$

CHINESE LANTERN - *Physalis alkekergi*



✂️ 21-25 🪴 15-30

63-4756-010 var. franchetii

Decorative perennial plants with orange fruits.

Hardiness zone: 3 Height (cm): 60-75

Spreading (cm): 90

1 pkg 100 s/p 3.59 \$

CINQUEFOIL - *Potentilla atrosanguinea*



✂️ 18 🪴 14-21

63-5540-010 Fireball Mix

Here is the first ever double flowered mixture with blooms of red, gold, orange and a few unique bicolours. This easy-to-grow perennial wears flowers all summer long when well established and is a good choice for poor and dry soil location.

Hardiness zone: 4 Height (cm): 80

Spreading (cm): 30

1 pkg 70 s/p 6.79 \$

MEXICAN HAT - *Ratibida columnifera*



✂️ 20-21 🪴 14-21

63-7146-010 Red Midget

Also known as 'Mexican Hat', it resembles a large rudbeckia, showing copper-red petals radiating around a long central cone. It is drought resistant.

Hardiness zone: 3 Height (cm): 30-60

Spreading (cm): 30-45

1 pkg 50 s/p 3.59 \$

CONFLOWER - *Rudbeckia fulgida*



✂️ 30 🪴 7-14

63-7364-010 Goldstrum

"Goldstrum" is one of the best perennial varieties on the market. We now offer a new seed technology, for faster and more uniform germination without a cold period. You can now enjoy these easier to grow, nice golden yellow black-centred coneflowers all summer long. **Primed seed**

Hardiness zone: 3 Height (cm): 60-70

Spreading (cm): 45-60

1 pkg 40 s/p 6.79 \$



Coneflower Prairie Glow



Sedum Acre Yellow



Hens & Chicks Hippiie Chicks



Salvia Salvatore Blue



Creeping Thyme Magic Carpet







White clover



Creeping Thyme Purple

CONEFLOWER - Rudbeckia triloba 

   15-18  10-14

63-7397-010 Prairie Glow

This stunning rudbeckia produces numerous 2.5 cm small yellow flowers with an orange centre and a dark eye. Short-lived perennial it reseeds easily and will decorate your garden for many years. If you pinch the plant early in the season, it will produce beautiful side shoots for more flowers.

Hardiness zone: 3 Height (cm): 100 Spreading (cm): 30-60

1 pkg 40 s/p 10.09 \$

SALVIA - Salvia nemorosa 

   20-22  4-8



63-7543-010 Salvatore Blue

It will flower the first year of sowing. With its high spikes of dark blue flowers, Salvia Salvatore Blue is a «wow» factor in any garden. It also attracts hummingbirds and pollinators!

Hardiness zone: 4 Height (cm): 25-30 Spreading (cm): 15-20

1 pkg 50 s/p 7.89 \$

SEDUM - Sedum 

  21  14-28



63-8102-010 Acre Yellow

1st year blooming. Creeping plant with green foliage.

Hardiness zone: 3 Height (cm): 10 Spreading (cm): 30-50

1 pkg 200 s/p 4.59 \$

HENS & CHICKS - Sempervivum sp 

 18-20  14-25



63-8320-010 Hippiie Chicks

An attractive structural plant for rock gardens, containers or for green roofs and can be used as a houseplant. Here is a beautiful mix of a variety of colors and sizes, succulent rosettes are resistant to our winters. The seed is pre-germinated which is used to break dormancy and ensure the seed is optimally germinating.

Primed seed Hardiness zone: 4 Height (cm): 13 Spreading (cm): 12.5-25

1 pkg 50 s/p 6.79 \$

CREeping THYME - Thymus serpyllum 

  18-21  10-21

63-8915-010 Magic Carpet

A selection of compact spreading thyme with a sweet fragrance of lemon. It is a perfect ground cover and is also floriferous in sunny locations. Can also be used to protect hilly areas from soil erosion.

Sowing rate: 1 pack of 250 seeds covers 5 square feet or 0,5 square meter area. Hardiness zone: 5 Height (cm): 5 Spreading (cm): 30

1 pkg 250 s/p 4.99 \$



63-8915-120 Magic Carpet

Sowing rate: 1 pack of 5000 seeds covers a 100 square feet or 10 square.

Hardiness zone: 5 Height (cm): 5 Spreading (cm): 30

1 pkg 5000 s/p 48.69 \$

CREeping THYME - Thymus serpyllum 

  18-21  14-21

63-8918-010 Purple

Scented foliage with purple flowers. **Sowing rate: 1 pack of 450 seeds covers a 10 square feet or 1 square meter area.**

Hardiness zone: 3 Height (cm): 10-15 Spreading (cm): 30-45

1 pkg 450 s/p 3.59 \$

63-8918-120 Purple

Scented foliage with purple flowers. **Sowing rate: 1 pack of 5000 seeds covers a 100 square feet or 10 square.**

Hardiness zone: 3 Height (cm): 10-15 Spreading (cm): 30-45

1 pkg 5000 s/p 14.49 \$

WHITE CLOVER - Trifolium repens 

  12-18  15

63-0095-300 White clover

White clover seeds are known for their high resistance to drought and to grubs that destroy lawns. Ideal for lawns in shady or sunny locations, white clover remains compact, does not require mowing and produces white flowers. **A bag of 250 grams covers : new lawn and damaged lawn : 7.5 m² (75 pi²) and overseeding 22.5 m² (225 pi²).**

Hardiness zone: 2 Height (cm): 15-20

1 pkg 250 g 6.79 \$

COLLECTIONS -ANNUAL, PERENNIAL & WILDFLOWER

Prepare the soil as you would for a lawn sowing. Remove all weeds. Choose a sunny location (at least 6 hours of sunlight per day). Mix one part of seeds with 10 to 15 parts of cement sand or of sawdust.

If it does not rain, make sure to water every day for the first two (2) weeks.

Germination (days) : 7-14

SHORT WILD FLOWER MIX

The Low Growing Seed Mixture is composed of annuals and perennials that are generally less than 40 cm (16 inches) tall at maturity. It is especially suitable for residential or commercial landscaping where height may be an issue.

Mix contains: *Osteospermum*, *Phacelia campanularia*, *Eschscholzia californica*, *Iberis*, *Dianthus plumarius*, *Centaurea*, *Oenothera biennis*, *Godetia amoena*, *Coreopsis lanceolata*, *Coreopsis tinctoria*, *Papaver nudicaule*, *Viola*, *Verbena tenuisecta*, *Cheiranthus allionii*, *Linaria maroccana*, *Lobularia maritima* and *Campanula carpatica*.



Product Code	Format (g)	Coverage (m ² / ft ²)	Price	Zone
63-0007-010	5	4 / 45	6.79 \$	3
63-0007-250	25	20,5 / 220	16.59 \$	3
63-0007-280	125	102/ 1100	60.49 \$	3



BIRD & BUTTERFLY WILD FLOWER

The Bird and Butterfly Mixture contains annuals and perennials flowers which will provide colorful blooms all season long as well as nectar and seed for songbirds, hummingbirds and butterflies.

Mix contains: *Rudbeckia*, *Gaillardia*, *Asclepias*, *Eschscholzia californica*, *Callistephus chinensis*, *Centaurea*, *Godetia amoena*, *Coreopsis lanceolata*, *Coreopsis tinctoria*, *Liatris*, *Monarda citriodora*, *Ratibida columnifera*, *Lupinus*, *Echinacea*, *Delphinium*, *Salvia splendens*, *Erysimum* et *Lobularia maritima*.

Product Code	Format (g)	Coverage (m ² / ft ²)	Price	Zone
63-0008-010	5	1.85 / 20	6.79 \$	3
63-0008-250	25	9.25 / 100	16.59 \$	3
63-0008-280	125	46.5 / 500	60.49 \$	3

CUT FLOWER MIX

For those who love bouquets of fresh flowers, this wildflower mixture is a colourful blend of both annual and perennial flowers that will make excellent long lasting cut flowers bouquets. Need a well-drained soil.

The mixture consists of *Cheiranthus*, *Chrysanthemum*, *Echinacea*, *Gypsophila*, *Lupinus*, *Callistephus*, *Centaurea*, *Gaura*, *Coreopsis*, *Cosmos*, *Delphinium*, *Gaillardia*, *Dianthus*, *Amni*, *Ratibida*, and *Rudbeckia*.



Product Code	Format (g)	Coverage (m ² / ft ²)	Price	Zone
63-0005-010	5	2.5 / 25	6.79 \$	3
63-0005-250	25	12.5 / 125	16.59 \$	3
63-0005-280	125	62.5 / 625	60.49 \$	3



FRAGRANT MIX

This mixture is a blend of colourful annuals and perennials that will offer lovely fragrances all season long.

Consist of: *Agastache*, *Amberboa*, *Calendula*, *Cheiranthus*, *Dianthus*, *Alyssum*, *Malcolmia*, *Mirabilis*, *Monarda*, *Papaver*, *Reseda*, *Tagettes*, and *Viola*.

Product Code	Format (g)	Coverage (m ² / ft ²)	Price	Zone
63-0003-010	5	3.25 / 32.5	6.79 \$	3
63-0003-250	25	16.25 / 162.5	16.59 \$	3
63-0003-280	125	81.75 / 880	60.49 \$	3

POLLINATOR MIX

Bees are the most predominant pollinators of flowering plants and they play a vital role in healthy ecosystems. Losses of natural food supplies and habitats have resulted in the decline of native bees and other pollinators. This is why we have decided to offer this mixture to supply flowers that provide nectar and pollen for native bees, honeybees, butterflies and other pollinators.

The mixture consist of Black-Eyed Susan, Blue Wild Indigo, Brown-Eyed Susan, Butterfly Milkweed, Eastern Columbine, Gray Goldenrod, Indian Blanket, Lance-Leaved Coreopsis, Lavender Hyssop, Lemon Mint, New England Aster, Ohio Spiderwort, Partridge Pea, Perennial Lupine, Plains Coreopsis, Purple Coneflower, Showy Tick Trefoil, Spotted Beebalm, White Upland Aster, White Rockcress and Wild Sunflower.



Product Code	Format (g)	Coverage (m ² / ft ²)	Price	Zone
63-0090-010	5	2.5 / 25	7.89 \$	3
63-0090-250	25	12.5 / 125	22.09 \$	3
63-0090-280	125	62.5 / 625	70.19 \$	3



NORDIC WILDFLOWER

A mixture that contains annual, biennial and perennial species well adapted to rigorous climates.

The mixture contains: Achillea, Asclepias, Centaurea, Cheiranthus, Chrysanthemum, Coreopsis, Digitalis, Echinacea, Eschscholtzia, Gypsophila, Hesperis, Liatris, Linum, Lunaria, Oenothera, Papaver, Rudbeckia and Silene.

Product Code	Format (g)	Coverage (m ² / ft ²)	Price	Zone
63-0002-010	5	5 / 50	6.79 \$	3
63-0002-250	25	50 / 500	16.59 \$	3
63-0002-280	125	250 / 2500	60.49 \$	3

ANNUAL AND PERENNIAL FLOWERS FOR DRY SOIL

This annual and perennial mixture is exceptionally drought-tolerant and is suitable for areas that receive de 25 to 75 cm (10 à 30") of precipitation annually. It is also suitable for very well-draining soils.

Mix contains: African daisy, Annual Baby's Breath, Blanketflower, Blue Flax, Blue Sage, California Bluebell, California poppy, Cornflower, Corn Poppy, Plains Coreopsis, Prairie Coneflower, Rocky Mountain Penstemon, Spurred Snapdragon, Sulphur Cosmos, and Sweet Alyssum.

Product Code	Format (g)	Coverage (m ² / ft ²)	Price	Zone
63-0006-010	5	4 / 43,5	6.79 \$	3
63-0006-250	25	20 / 217,5	16.59 \$	3
63-0006-280	125	100 / 1100	60.49 \$	3



COMPANION FLOWER

This collection is made of varieties that deter or trap garden pests.

Collection consists of 1 packet each of : Calendula mixture (deters worms from tomato plants), Nasturtium mixture (traps aphids, deters squash bugs and striped pumpkin beetles), Marigold mixture (controls nematodes, deters aphids and whiteflies).



Product Code	Format	Price
61-0040-010	1 unit	11.09 \$

EDIBLE FLOWERS

Edible flowers are popular. They are not only nice in the garden or patio containers, but also pretty to serve and eat. Harvest and use fresh in salads, with desserts like creams, vegetables or fish or keep them in oil.

Collection consists of 1 packet each of Anise (petals), Nasturtium (petals and flowers), Dianthus (remove the white part retaining the petals), Sunflower (flower buttons, petals, seeds), Viola mixture (petals, flowers).



Code	Format	Price
61-0020-010	1 unit	14.49 \$

«Les Semences Marie-Victorin» suggests a collection of native plant seeds that will entice the amateurs for the products of our horticultural heritage.



Black spruce



Black walnut



Old Field Birch



Red Oak



Sugar Maple



Alternate-leaved Dogwood



Black Chokeberry

Variety Code	Expo.	Hardiness Zone	Height	Spread	Soil	Variety Description	Price 1 Pkg
Trees							
68-2010-010 Black spruce	☀	1a	15 - 20 m	6 m	moist	The Picea mariana evokes the vast boreal expanses of Quebec. It is also the tree from which the famous spruce beer is made. Proudly cultivate this emblem of our forests.	\$ 5.00 100 s/p
68-2002-010 Black walnut	☀☀	4b	27 - 30 m	25 m	cool	Juglans nigra is not indigenous to Quebec having been introduced at the end of the 19th century by "le Seigneur Joly de Lotbinière". Its growth is slow and long, but is a wonderful gift for generations to come. This specie requires deep, well-drained soil in order to establish its generous root system.	\$ 5.00 3 s/p
68-2004-010 Old Field Birch	☀	1	7,5 - 10 m	3 m	cool or dry	The Betula populifolia has red only the name because its decorative bark is perfectly white with large triangular black markings. Suitable for sandy and poor soils, it is perfect for places that were once bare and need to be refurbished.	\$ 5.00 500 s/p
68-2003-010 Red Oak	☀	3a	30 m	20 m	cool or moist	Quercus rubra is one of the most majestic trees of our flora. Its autumn coloration is magnificent and, although it is a slow-growing tree, it is among the oaks the fastest growing.	\$ 5.00 10 s/p
68-2000-010 Sugar Maple	☀☀☀	3	25 - 30 m	20 m	cool	Acer saccharum is a large native tree with flaming autumnal colours. Its sap, transformed into sirup, is a treat for young and old, since the dawn of time. Cultivate this beautiful emblem of our forests on your land.	\$ 5.00 10 s/p
Shrubs							
68-2036-010 Alternate-leaved Dogwood	☀	3	3 - 6 m	2,5 m	cool or moist	Cornus alternifolia very elegant and surprising with its branches developing in horizontal layers. Slow in growth, this native shrub is perfectly adapted for city gardens. Furthermore, the birds are very fond of its dark fruits.	\$ 5.00 15 s/p
68-2005-010 Black Chokeberry	☀	1	90 - 200 cm	150 cm	cool, moist or soaked	Black Chokeberries are little-known fruits originating from the Aronia melanocarpa . At ease in acid soils, this plant produces lovely white flowers highlighted by shiny foliage.	\$ 5.00 15 s/p

PART OF OUR NATURAL HERITAGE IN YOUR GARDEN



Button-bush



Canadian Elder



Choke Cherry



Cranberry-tree



Nine-bark



Red-osier Dogwood



Vinegar-tree



Wild holly

Variety Code	Expo.	Hardiness Zone	Height	Spread	Soil	Variety Description	Price 1 Pkg
Shrubs							
68-2031-010 Button-bush	☀️☀️	4	1.5 - 3 m	1 m	moist	Cephalanthus occidentalis is a native shrub of rare beauty whose spherical flowers have an enchanting lilac scent. Since it prefers moist soils, it will grow splendidly on the edge of a pond.	\$ 5.00 15 s/p
68-2081-010 Canadian Elder	☀️☀️	3	2 - 3 m	3 m	cool	The Sambucus canadensis is an ornamental native shrub with pretty white flowers. Its fruits are edible and delicious processed into pies or jams. It is one of the rare fruiting shrubs that does not require full sun.	\$ 5.00 15 s/p
68-2065-010 Choke Cherry	☀️	2	3 - 4.5 m	3 m	cool or dry	Prunus virginiana produces an abundance of sparkling fruits that birds love. They can be picked to make jam. Fast-growing, this small native tree is easy to grow and tolerates poor soils.	\$ 5.00 10 s/p
68-2091-010 Cranberry-tree	☀️☀️☀️	2	2 - 3 m	2 m	cool	The Viburnum trilobum is a beautiful native shrub appreciated for its spectacular fall colouring and large white flowers. Its bright red fruits remain in place during the winter. The fruits are edible and appreciated by birds.	\$ 5.00 15 s/p
68-2061-010 Nine-bark	☀️☀️	2a	2.5 - 3.5 m	3 m	cool, dry or moist	Physocarpus opulifolius is a decorative native shrub with a textured bark that peels gracefully. With an abundant flowering, it forms natural-looking groves where birds are abundant.	\$ 5.00 15 s/p
68-2037-010 Red-osier Dogwood	☀️☀️	1	1 - 3 m	2 m	cool or dry	Cornus stolonifera owes its name to its bright red branches that contrast beautifully with the winter scenery. Fast growing and vigorous, this native shrub is suitable for rustic settings.	\$ 5.00 15 s/p
68-2071-010 Vinegar-tree	☀️☀️	3	2 - 4 m	4 m	cool or dry	The Rhus typhina is a large, vigorous native shrub with a spectacular fall coloration. Traditionally, its red fruits are used in the preparation of delicious pink lemonade.	\$ 5.00 15 s/p
68-2055-010 Wild holly	☀️☀️☀️	2	2 - 5 m	2 m	cool, moist or soaked	The Nemopanthus mucronatus is a very beautiful rustic shrub with decorative matt red fruits. To be grown in cool or moist soil in an acidic substrate.	\$ 5.00 15 s/p

PART OF OUR NATURAL HERITAGE IN YOUR GARDEN



Winterberry



Witch Hazel



Canada Reed-grass



Vanilla Grass



Common rush



Blackish bulrush



Pectinate Spartina

Variety Code	Expo.	Hardiness Zone	Height	Spread	Soil	Variety Description	Price 1 Pkg
Shrubs							
68-2051-010 Winterberry	☀️☀️	3	1 - 4 m	2 m	cool, moist or soaked	Once autumn comes, the female plants of the <i>Ilex verticillata</i> are adorned with a multitude of red fruits. This hardy native shrub is easy to grow as long as it is grown in cool or humid soil.	\$ 5.00 100 s/p
68-2040-010 Witch Hazel	☀️☀️	4b	1,75 - 2,50 m	3 m	cool or moist	The <i>Hamamelis virginiana</i> is a superb shrub with a somewhat twisted habit with a generous foliage. Its light yellow bloom comes in autumn and fills the air with a sweet fragrance.	\$ 5.00 10 s/p
Grasses							
68-3030-010 Blackish bulrush	☀️	3	80 - 120 cm	25 cm	moist or soaked	The <i>Scirpus atrovirens</i> is a large, sturdy grass that likes to have its feet in the water, making it ideal for ponds. Close to the water, its slender habit makes it a perch of choice for many birds.	\$ 5.00 1000 s/p
68-3011-010 Canada Reedgrass	☀️	3	150 cm	60 cm	cool, moist or soaked	<i>Calamagrostis canadensis</i> is an exceptionally hardy native ornamental grass. It prefers cool soils, but tolerate other soil types. Its golden spikes take on a most elegant pinkish coloration as the summer progresses.	\$ 5.00 500 s/p
68-3025-010 Common rush	☀️	3	45 - 65 cm	60 cm	moist or soaked	The <i>Juncus effusus</i> is a slender grass that beautifully decorates the edges of bodies of water. Traditionally, it was used to make many basketry objects. In a garden, it is both pretty and useful for wildlife.	\$ 5.00 1000 s/p
68-3035-010 Pectinate Spartina	☀️	3	80 - 150 cm	60 cm	cool or moist	The <i>Spartina pectinata</i> is a large grass that takes root vigorously. In the past, it was used to build thatched roofs. Nowadays it is along the crumbly banks that it renders precious services by retaining the soil.	\$ 5.00 100 s/p
68-3022-010 Vanilla Grass	☀️	3	25 - 45 cm	35 cm	cool	<i>Hierochloa odorata</i> is an indigenous grass much sought after for its vanilla scent. The natives used it during spiritual ceremonies. This plant, easy to cultivate, will awaken your senses.	\$ 5.00 15 s/p

PART OF OUR NATURAL HERITAGE IN YOUR GARDEN



Climbing Bittersweet



Virginia Creeper



Virginia Virgin's Bower



Wild Grape

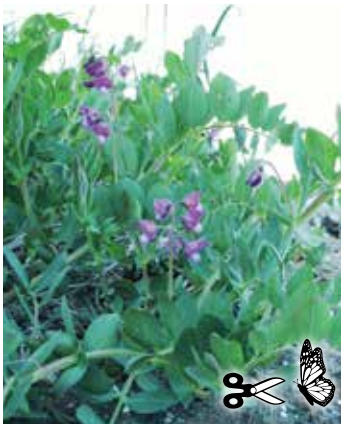

Beach Pea



Blue Vervein



Canada Goldenrod



Common milkweed

Variety Code	Expo.	Hardiness Zone	Height	Spread	Soil	Variety Description	Price 1 Pkg
Climbing							
68-4021-010 Climbing Bittersweet	☀️☀️☀️☀️	4	2 - 8 m	3 m	cool	The Celastrus scandens is a native climbing plant whose red and yellow fruits offer a colourful show in autumn. In the garden, it is a wonderful addition to fences, trellises, and pergola.	\$ 5.00 15 s/p
68-4041-010 Virginia Creeper	☀️☀️☀️☀️	2	4 - 10 m	1 m	cool	The Parthenocissus quinquefolia charms by its magnificent autumn colours. Of fast growth it adapts to both sun and shade. In the garden, it is a wonderful addition to fences, trellises and pergolas.	\$ 5.00 15 s/p
68-4026-010 Virginia Virgin's Bower	☀️☀️☀️☀️	3	2 m	60 cm	cool	The Clematis virginiana is a native climbing plant of the clematis family. Its abundant white flowers have an undeniable country charm. In the garden, it is a wonderful addition to fences, trellises, and pergolas.	\$ 5.00 15 s/p
68-4061-010 Wild Grape	☀️☀️☀️☀️	2	1,5 - 6 m	1 m	cool, moist or dry	The Vitis riparia produces grapes that were used by our grandmothers to make jams or jellies. Easy to grow, this native climbing plant is perfect for fences, trellises and pergolas in both shade and sun.	\$ 5.00 15 s/p
Perennials							
68-5055-010 Beach Pea	☀️	3	15-30 cm	60 cm	dry	The Lathyrus maritimus is a magnificent legume whose flowers form clusters that can reach 10 cm long. Companion plant of the elyrium of sands, important for the fixation of sandbanks in maritime region. Very decorative bluish foliage.	\$ 5.00 15 s/p
68-5091-010 Blue Vervein	☀️☀️☀️	4	60 - 180 cm	45 cm	cool, moist or soaked	Verbena hastata produces a multitude of small blue flowers on long spikes that rise above the plant. This beautiful, hardy native is an incomparable choice at the edge of a pond or as a bedding plant in cool soil.	\$ 5.00 1000 s/p
68-5080-010 Canada Goldenrod	☀️	3	60 -150 cm	30 cm	cool or dry	The Solidago canadensis has long been renowned in Europe for its medicinal and ornamental qualities. At home, this flower makes the happiness of beneficial insects and butterflies during the most beautiful summer days.	\$ 5.00 1000 s/p
68-5010-010 Common milkweed	☀️	2	90-100 cm	40 cm	cool or dry	The Asclepias syriaca are flowers with a bewitching perfume. Essential for the reproduction of the monarch butterfly, they are easy to cultivate in a well drained soil. The schoolchildren will be happy to carry out sowings intended for such pretty bugs.	\$ 5.00 15 s/p

PART OF OUR NATURAL HERITAGE IN YOUR GARDEN

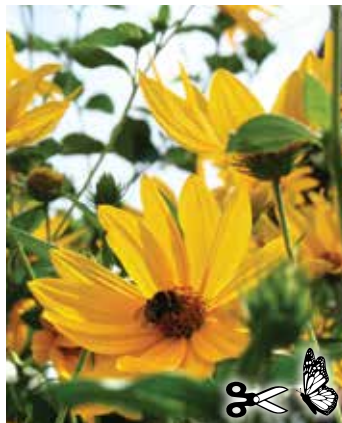

False Sunflower



Firewood



Giant St. John's-wort



Golden meadow-parsnip



Joe-Pye-weed



Larger Blue-Flag



Life-everlasting



New England Aster

Variety Code	Expo.	Hardiness Zone	Height	Spread	Soil	Variety Description	Price 1 Pkg
Perennials							
68-5041-010 False Sunflower	☀	4	90 - 125 cm	55 cm	cool	The Heliopsis helianthoides is a native perennial flower that looks like small sunflowers. It blooms earlier than its cousins, allowing you to enjoy sunny bouquets longer.	\$ 5.00 100 s/p
68-5031-010 Firewood	☀	2	130 - 200 cm	40 cm	cool or dry	Epilobium angustifolium have long slender stems that are covered with a multitude of pink flowers in the heart of summer. It is hard to imagine that such small seeds can give birth to such large and vigorous native plants.	\$ 5.00 1000 s/p
68-5045-010 Giant St. John's-wort	☀	4	60 - 100 cm	60 cm	cool or moist	The Hypericum pyramidatum is a beautiful native perennial whose lemon-yellow flowers can reach 5 cm in diameter. Very floriferous in rich soil, it forms copses with generous foliage.	\$ 0.00 1000 s/p
68-5095-010 Golden meadowparsnip	☀☁	3	30 - 90 cm	40 cm	cool, moist or soaked	The Zizia aurea is a flower whose early blooming delights many beneficial insects in search of spring nectar. Its very finely cut foliage offers an interesting contrast to wetland plants of a generally more rudimentary texture.	\$ 5.00 195 s/p
68-5035-010 Joe-Pye-weed	☀☁	3	100 - 150 cm	60 cm	cool, moist or soaked	The Eupatorium maculatum is a flower that is very suitable for humid places. It also works wonders when planted at the edge of a water basin. Regularly visited by butterflies, it adds life to the garden.	\$ 5.00 1000 s/p
68-5051-010 Larger Blue-Flag	☀☁	2	45 - 65 cm	50 cm	cool, moist or soaked	The Iris versicolor is the floral emblem of Quebec since 1999. It is at the approach of the national holiday, June 24th, that we can see its magnificent blue, white and yellow flowers. Perfect for a water garden and its surroundings.	\$ 5.00 15 s/p
68-5005-010 Life-everlasting	☀	3	30 - 50 cm	40 cm	dry	Anaphalis margaritacea is a indigenous perennial plant with silvery gray foliage with velvety texture. Typical of dry and rocky soils, it is suitable for gardens that receive little water or drain quickly. Perfect for sunny flowerbeds.	\$ 5.00 1000 s/p
68-5013-010 New England Aster	☀	3	50 - 150 cm	30 cm	cool or dry	The Aster novae-angliae is the most colorful and flowering of all Asters in North America. Cultivate it in groves to take full advantage of its slightly camphorated scent. Ideal for your country gardens.	\$ 5.00 1000 s/p

PART OF OUR NATURAL HERITAGE IN YOUR GARDEN



Pokeweed



Snakehead



Swamp milkweed



Swamp Sunflower



Victorin's Evening Primrose



Wild Bergamot



Wild Columbine

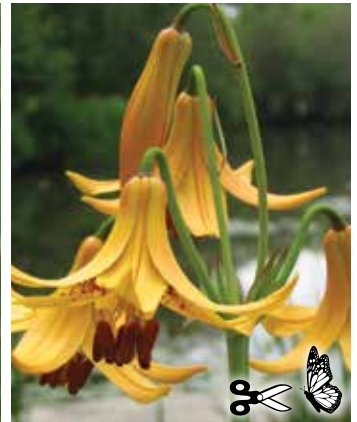

Wild Yellow Lily

Variety Code	Expo.	Hardiness Zone	Height	Spread	Soil	Variety Description	Price 1 Pkg
Perennials							
68-5070-010 Pokeweed	☀	5	90 - 300 cm	50 cm	cool or moist	The Phytolacca americana is a rare plant with stems of an intense pink. In a rich soil, it is spectacular. It produces abundant black fruits which were used by the Amerindians to dye fabrics purple.	\$ 5.00 15 s/p
68-5015-010 Snakehead	☀☀☀	3	30 - 90 cm	45 cm	cool, moist or soaked	The Chelone glabra with its white flowers tinted with pink is a plant whose growth is rather fast. One will thus provide it with enough space to develop. It appreciates humid, peaty and even swampy conditions.	\$ 5.00 1000 s/p
68-5009-010 Swamp milkweed	☀☀☀	3	30 - 120 cm	40 cm	cool, moist or soaked	People who love butterflies, monarchs in particular, should make a point of cultivating Asclepias incarnata . It will enjoy the company of other North American milkweed, such as tuberous and common milkweed. Bright and fragrant blooms.	\$ 5.00 15 s/p
68-5040-010 Swamp Sunflower	☀	4	30 - 100 cm	30 cm	cool or moist	The Helianthemum autumnale is a hardy perennial that tolerates heavy, clayey soils. Its petals, of a brilliant yellow, end in three points which give the plant a unique appearance.	\$ 5.00 1000 s/p
68-5065-010 Victorin's Evening Primrose	☀	2	65 - 125 cm	25 cm	dry	The Oenothera victorinii is one of the few flowers dedicated to Brother Marie-Victorin. Its flowers open at the end of the day and remain open all night. This makes it an important plant for some moths.	\$ 5.00 1000 s/p
68-5063-010 Wild Bergamot	☀	4	45 - 90 cm	45 cm	cool	The Monarda fistulosa is a fragrant and vigorous native perennial. It does not fear competition from other flowers and is more resistant to disease than other bee balms. Easy to grow and easy to love.	\$ 5.00 1000 s/p
68-5007-010 Wild Columbine	☀☀☀	3	30 - 60 cm	30 cm	cool or moist	The Aquilegia canadensis enjoy rocky soils and rocky crevices. This makes them highly appreciated for cultivation in troughs or rocky outcrops. Their red yellow flowers are of great beauty and attract hummingbirds.	\$ 5.00 15 s/p
68-5061-010 Wild Yellow Lily	☀☀☀	4	100 - 150 cm	45 cm	cool or moist	The Lilium canadense is one of the most beautiful native flowers of Quebec. Although they are slow to produce from seed, the challenge is worth it because their beauty is unequalled. « See the lilies of the field ... » Brother Marie-Victorin.	\$ 5.00 10 s/p

STRAWBERRY PLANT PLUGS



84-3840-MO5 ALBION STRAWBERRY PLUG 5/PKT

TIME FROM PLANTING TO FLOWERING : 5-6 weeks

TIME FROM FLOWERING TO FRUITS : 5-6 weeks

TOTAL TIME TO GET FRUITS : 10-12 weeks

FERTILIZER : Fertilize regularly as you do for your annual flowers plants.

SPREADING : 25-30 cm

FLOWERING : Continuous but can decrease during a heatwave period.

HARVEST : June to September

EXPOSITION : Sun



Quickly and easily grow your strawberries with these strawberry plugs

GROWER'S TIP

Plant the plugs as soon as possible after receipt, since the plants are in a growth period. If you cannot plant them quickly, keep them in a cold area at 5°C. It is very important for the plant, not to miss water during the flowering period, in order to have beautiful fruits.

1 pkg (5 plants) 13.20\$

3 pkgs or more 11.88\$/each

Nothing is easier than growing your own strawberries with these large plugs! In the garden, on a balcony bag, hanging basket or patio containers, these strawberry plants grow faster. The floral initiation period is done in the fall and then the plants are kept in cold storage until planting at spring. The day neutral Albion variety produces fruit until September contrary to short day varieties that give a concentrated production for three weeks. Each plant can bear up to 30 flowers! The firm fruits are bright red, sweet, tasty and have a high level of antioxidant properties which is beneficial for your health. Albion is a well-known variety used by field growers.

WINTER PROTECTION

Open ground: Protect with a good layer of dried leaves, straw or mulch. In spring, clear plants of protection and allow them space to grow.

WINTER PROTECTION SUGGESTIONS CONTAINER OR HANGING BASKET

Let plants experience a few touches of frosts to stimulate their dormancy. Then, place them in a slightly heated area (garage or cold room). Water them lightly, just enough to prevent drying out. You could also dig a hole in the garden and place the container there in the hole for the winter. Fill the space around the container with soil and cover the container and the plant with mulch. In the spring, dig up, clean, and rehang. Remove the plants from the container and plant them in the ground for the winter, covering them well with mulch. In springtime, replot your plants.

STRAWBERRY BY SEEDS

Original and decorative that will produce all summer long.

Customized for culture out of pots or hanging baskets, they are ideal for urban gardeners. Since these plants are perennials, you can also have them in your garden.

1 pkg (20 s/p) 11.09\$ 3 pkgs or more 9.98\$/each

GERMINATION TEMPERATURE

22 °C

GERMINATION

10-14 days

USE

Flower box, container, hanging plant

HEIGHT

25-30 cm

SPREADING

30 cm

HARVEST

June to September

EXPOSITION

Sun



64-3816-010 Ruby Ann F1

Produces a ruby-red cascade of flowers and sweet fruits during whole summer. Fruits are medium sized and have typical strawberry-like conical shape. Very sweet fruits.



64-3823-010 Gasana F1

Large pink flowers, plant will produce many runners and very sweet conical fruits.

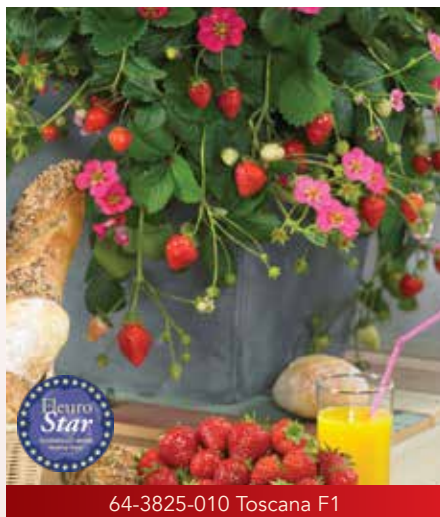

64-3825-010 Toscana F1

Large, very bright pink flowers (5 cm). Fruits are conical, very tasty and fragrant.



64-3821-010 Delizz® F1

First ever AAS strawberry winner, Delizz® is easy to grow and will produce an abundant harvest throughout the growing season. Ever bearing variety, climbing, producing few runners. White flowers, green foliage and shiny dark red fruits.



64-3855-010 Summer Breeze Rose F1

Produces double dark rose flowers followed by an abundance of sweet conically shaped, medium-large fruits for the entire summer.

GROWER'S TIP

For best results, start sowing indoors under glass or plastic and keep moist. Lightly cover the seeds with vermiculite. Once sprouted, maintain at cool temperatures (night temperatures at 10 °C). Transplant outside using a greenhouse tunnel or plastic non-heated tunnels. Requires lots of light.

For winter protection refer to strawberry plants plugs

POTATOES

The potato - delicious and nutritious !

Prefer a well-drained soil with lots of organic matter. Due to the sensitivity of the products, climatic variations and complexity of transport operations, W.H. Perron informs you that unfortunately, the products of this order form will no longer be shipped to these regions: Newfoundland and Labrador / PE. I. / Quebec JOM / Alberta / Saskatchewan / Manitoba / Nunavut / Yukon / N.W.T and British Columbia, in the regions with postal codes starting with: A / C / JOM/ R/ S/ T/ V/ X/ Y. Quebec (except JOM), Ontario, New Brunswick and Nova Scotia.



Chaleur



Chieftain



Double Fun



Mix Bleu, Blanc, Rouge



Norland

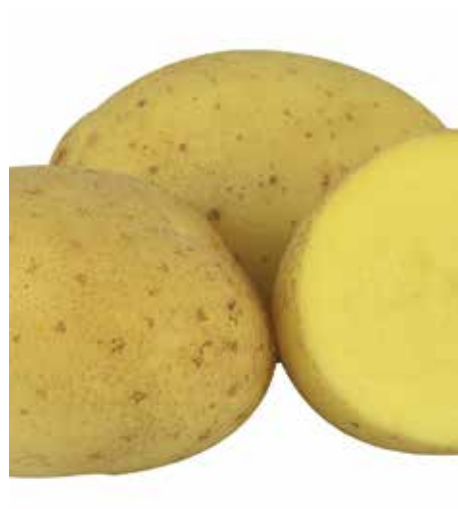

'Vivaldi'

Variety Code	Variety Description	Price 1 Pkg
Potatoes Delivery May 2025		
59-7009-390 Chaleur	Canadian variety named for its improved tolerance to hot and dry conditions. High yield of very early large tubers with average storability. 'Chaleur' is one of the only varieties with which you can make French fries as soon as the second day after harvest. Also, excellent for boiling and baking. (Early - Maturity 90 days)	13.30 \$ 1,5 kg
59-7045-390 Chieftain	Round tubers with bright red skin and white flesh. Very good resistance to scab and other diseases. High yield. For boiling. Plants of medium height with a spreading habit. (Mid-season - Maturity 115 days)	13.30 \$ 1,5 kg
59-7003-390 Double Fun	"Double Fun" has beautiful dark purple flesh and skin. It has the same taste and nutritional value as regular potatoes. When cooked, it will retain its beautiful color. Avoid very dry soils, if there is no irrigation to harvest large quantities. High yield. (Mid-season - Maturity 100 days)	14.70 \$ 1,5 kg
59-7000-390 Mix Bleu, Blanc, Rouge	Have fun in growing potatoes in different colours and with different maturities. This mixture contains bulbs of Double Fun (mid-season, blue) , Chaleur (early, white) and Chieftain (mid-season, red) .	14.70 \$ 1,5 kg
59-7022-390 Norland	Round to oblong red skin and white flesh tubers. Store very well from August to December. Not subject to internal necrosis. Very good mashed, boiled and also great French fries since it absorbs less oil. (Early - Maturity 95 days)	13.30 \$ 1,5 kg
59-7010-390 'Vivaldi'	Replacing Yukon Gold variety, Vivaldi is the new benchmark in the category of yellow-fleshed potatoes. Recognized for its exceptional taste and texture, it also produces a high yield. A variety with a low caloric intake that keeps very well. (Mid-season - Maturity 105 days)	13.30 \$ 1,5 kg

SHALOTT AND ONION - BULBS

Due to the sensitivity of the products, climatic variations and complexity of transport operations, W.H. Perron informs you that unfortunately, the products of this order form will no longer be shipped to these regions: Newfoundland and Labrador / P.E. I. / Quebec JOM / Alberta / Saskatchewan / Manitoba / Nunavut / Yukon / N.W.T and British Columbia, in the regions with postal codes starting with: A / C / JOM/ R/ S/ T/ V/ X/ Y. Quebec (except JOM), Ontario, New Brunswick and Nova Scotia.

GROWING METHOD

Planting: Sow in spring, in a firm bed, when the soil is easily manageable. **Soil:** Grow on an open site in a light to medium, fertile, well-drained soil. An all-purpose fertilizer can be added to the bed before seeding. Requires small amount of nitrogen. **Spacing:** Insert bulbs into the soil, spacing them apart about 8 cm to 10 cm. **Growing tips:** Always remove weeds. Onions have relatively few roots and once established, requires little water. Plant in a sunny area. **Harvest:** When mature, the leaves turn brown and die. To eat fresh, remove from soil as needed. For storage, ensure outer skins are completely dry.



White Canada #1



French

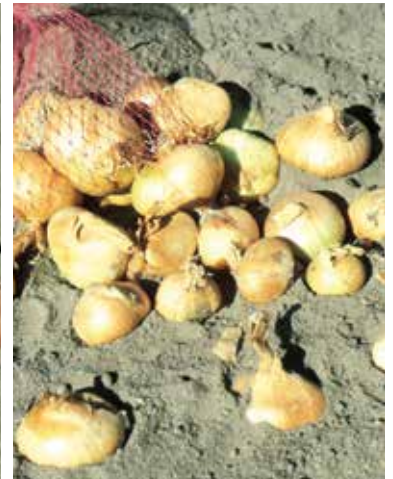

Multiplier or potato onion



Yellow Canada #1



Red Canada #1

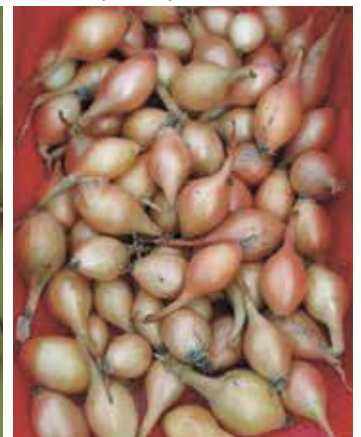

Spanish

Variety Code	Variety Description	Price 1 Pkg
Shallot - Delivery early May 2025		
95-4015-320 French	Onion forming a packet of shallots that will mature, and in turn, will mature into a packet of bulbs. Only the red bulb is used, the taste of the tops being too strong. 10 bulbs /pkg.	5.90 \$ pqt
95-4019-320 Multiplier or potato onion	Onion forming a bunch of shallots (7 to 8). Leave 15 to 20 cm between the little bulbs. 15 bulbs /pkg	6.30 \$ pqt
Onion set - Delivery early May 2025		
95-6619-320 White Canada #1	Used for the consumption of shallot tops or of onions when mature. 100 bulbs / pkt	4.30 \$ pqt
95-6612-320 Yellow Canada #1	The onion sets, when transplanted in the garden in the spring, make early harvests of delicious bunching onions. The shallot bunching onions are ready to enjoy in just two (2) weeks, cooking onions in eight (8) weeks! Try it! 100 bulbs / pkt	4.20 \$ pqt
95-6616-320 Red Canada #1	More and more popular for cooking or in salads, you can grow red onions more rapidly with red onion sets. Red onions are the onions with the sweetest taste. 100 bulbs / pkt	4.30 \$ pqt
95-6613-320 Spanish	The Spanish onion set is different from the yellow onion by its round shape. It also has a milder and a sweeter taste than yellow onion. Use fresh. 100 bulbs / pkt	4.30 \$ pqt

ORDER FORM



STRAWBERRY PLANT PLUGS, POTATOES AND ONIONS

In 2025, you will have the choice of 2 different order forms.

1. Strawberry plant plugs, potatoes and onions.
2. Seeds and accessories.

STRAWBERRY PLANT PLUGS, POTATOES AND ONIONS		SHIPPING : APRIL - MAY (after last risk of frost)
UNIT PRICES	UNIT PRICE FOR 3 PACKAGES OR MORE OF THE SAME PRODUCT CODE	<p>Due to the sensitivity of the products, climatic variations and complexity of transport operations, W.H. Perron informs you that unfortunately, the products of this order form will no longer be shipped to these regions : Newfoundland and Labrador / P.E.I. / Quebec JOM / Alberta / Saskatchewan / Manitoba / Nunavut / Yukon / N.W.T. and British Columbia.</p>
\$ 4.10	\$ 3.69	
\$ 4.20	\$ 3.78	
\$ 5.00	\$ 4.50	
\$ 5.90	\$ 5.31	
\$ 6.30	\$ 5.67	
\$ 11.50	\$ 10.35	
\$ 13.30	\$ 11.97	
\$ 14.70	\$ 13.30	

				Carry on total A	
1. MEMBERS of a horticultural society registered with the OHA OR FSHEQ ** Membership code #				-10% of total A	-
				Subtotal B	=
2. FIXED HANDLING AND SHIPPING FEES Quebec (except JOM postal codes), Ontario, New Brunswick and Nova Scotia					\$11.95
				Subtotal C	=
3. TAXES – add the appropriate taxes according to your region					
Quebec	(5 % GST + 9,975 % QST)			14,975 % to subtotal C	+
Ontario				13 % HST to subtotal C	+
New Brunswick / Nova Scotia				15% HST to subtotal C	+
				Subtotal D	=
4. GIFT CARD – deduct the amount of a gift card or credit note you may have. Return card or note with your order.					-
5. DEBIT NOTE – add the amount of a balance due on a previous order. Return the debit note with your order.					+
				TOTAL	=



						Carry on total A		
1. MEMBERS of a horticultural society registered with the OHA or FSHEQ ** Membership code number						OHA or FSHEQ	-10% of total "A"	-
						Subtotal B	=	
2. HANDLING AND SHIPPING FEES Quebec (except JOM postal codes), Ontario, New Brunswick and Nova Scotia.						If total "A" is between :		You pay
						\$0.1 - \$99.99	→ \$18.95	+ \$
						\$100.00 or more	→ FREE SHIPPING	
*** A shipping surcharge can be added to heavy or oversized items. (Indicated in the description of the relevant items.)						Additional shipping charge →		+ \$
3. HANDLING AND SHIPPING FEES Newfoundland and Labrador / P.E.I. / Quebec JOM / Alberta / Saskatchewan / Manitoba / Nunavut / Yukon / N.W.T. and British Columbia. (Postal codes starting with A - C - JOM - R - S - T - V - X et Y)								+ \$ 24.95
*** A shipping surcharge can be added to heavy or oversized items. (Indicated in the description of the relevant items.)						Additional shipping charge →		+ \$
						Sous-total C		
4. TAXES – add the appropriate taxes according to your region								
Quebec						(5 % GST + 9,975 % QST)	14,975 % to subtotal C	+
Ontario							13 % HST to subtotal C	+
New Brunswick / Nova Scotia / Newfoundland and Labrador/ P.E.I.							15% HST to subtotal C	+
Alberta/Manitoba/Nunavut/Yukon/T.N.O/Saskatchewan/Colombie-Britannique							5 % GST to subtotal C	+
						Subtotal D	=	
5. GIFT CARD – deduct here the amount of a gift card or of a credit note you may have. Enclose the card or note with your order.							-	
6. DEBIT NOTE – add the amount of a balance due on a previous order. Return the debit note with your order.							+	
						TOTAL	=	

***** SEEDS *****	
LIST OF UNIT PRICES FOUND IN THE CATALOGUE	
UNIT PRICES	UNIT PRICES FOR 3 PACKAGES OR MORE OF THE SAME PRODUCT CODE
\$ 3.59	\$ 3.23
\$ 4.59	\$ 4.13
\$ 5.00	\$ 4.50
\$ 5.69	\$ 5.12
\$ 6.79	\$ 6.11
\$ 7.89	\$ 7.10
\$ 10.09	\$ 9.08
\$ 11.09	\$ 9.98
\$ 14.49	\$ 13.04
\$ 16.59	\$ 14.93
\$ 22.09	\$ 19.88
\$ 30.69	\$ 27.62
\$ 60.49	\$ 54.44
\$ 79.19	\$ 63.17

1. ** Membership Code Number. Members of an horticultural society are entitled to 10% rebate on all orders made at W.H. Perron, IF, his horticultural society is, in turn, registered to the Ontario Horticultural Association or the Fédération des sociétés d'horticulture et d'écologie du Québec (FSHEQ).



Enter, in the appropriate boxes, the 4-digit membership code numbers of your society and deduct 10% on your total in «A».

If you do not have the correct membership code number, you will not be able to benefit the rebate. Contact your horticultural society.



FOR ANY QUESTIONS OR FURTHER INFORMATION, DO NOT HESITATE AND CONTACT A W.H. PERRON REPRESENTATIVE. ALWAYS HAPPY TO HELP YOU.

450 682-9071 / 1 800 723-9071
mail@whperron.com

GREENHOUSE VEGETABLES



Scorpio F1



Camaro F1



Picolino F1



DR7109CB F1



Emerite



DR0719PB F1



Berkeley F1



Dexter F1



DR0603TC F1



Komeett F1



Pink ID F1



Trust F1

Variety Code	Form.	Colour	Type	Variety Description	Price 1 Pkg
Greenhouse Eggplant					
66-0615-01N Scorpio F1	UNT EXCL.	Purple	Oval	Dark, shiny, half-long (20 cm - 25 cm) fruits with a small calyx. Uniform selection with average fruit weight of 350 gr - 400 gr. Beautiful presentation and attractive fruits that are easy to harvest.	22.09 \$ 10 s/p
Greenhouse Cucumber					
66-4241-010 Camaro F1	TR EXCL.	Green	English	Greenhouse cucumber with a very vigorous plant that will produce long and straight, slightly fluted, fruits. Intermediate tolerance to Powdery Mildew. Excellent quality.	16.59 \$ 10 s/p
66-4211-01B Picolino F1	EXCL.	Green	Mini	Mini greenhouse cucumber, crispy and firm, with a refreshing sweet taste. This vigorous and compact plant is early to produce an average of 3-4 fruits per node.	16.59 \$ 20 s/p
66-4220-01N Snacking DR7109CB F1	UNT EXCL.	Green	Mini	Cute, dark green, snacking cucumber of an average length of 9 cm and a weight of 35 gr - 40 gr. 7109 will provide good yields of crunchy, healthy fruits in your greenhouse.	22.09 \$ 10 s/p
Greenhouse Bean					
66-4301-01N Emerite	UNT EXCL.	Green	Fine	Emerite is a long and elegant filet pole bean. The pods of these classic beans are slim, rounded, and grow 17 cm - 22 cm long. Emerite's flavour is sweet, delicate, and the pods have a crispy snap that makes them especially delicious when just briefly steamed or quickly stir-fried. Emerite's tall vines (up to 2.4 m) are vigorous and productive.	7.89 \$ 50 s/p
Greenhouse Pepper					
66-7278-01N DR0719PB F1	UNT EXCL.	Orange	Bell	Nice large, shining orange greenhouse pepper, fleshy and sweet.	22.09 \$ 10 s/p
66-7282-01N Berkeley F1	UNT EXCL.	Yellow	Bell	Yellow pepper that shows an excellent quality, a constant square shape and a uniform size throughout the season.	22.09 \$ 10 s/p
66-7288-01N Dexter F1	UNT EXCL.	Red	Bell	Bell-type red pepper. Dexter ripens quickly, allowing you to quickly enjoy a fresh, crispy chili straight from your greenhouse.	22.09 \$ 10 s/p
Greenhouse Tomato					
66-9079-01N DR0603TC F1	UNT EXCL.	Red	Grape	This small greenhouse grape tomato is simply exceptional! Very sweet and well balanced taste. Yield is impressive, you can harvest fresh tomatoes for a long period of time.	22.09 \$ 10 s/p
66-9085-01N Komeett F1	UNT EXCL.	Bright red	On the vine	With its high yield, Komeett is easy to grow and provides fruits all summer long. The fruits weigh around 155 grams. The yield is good even under low light conditions. The trusses are very uniform with an average of 5 bright red, tasty fruits each.	16.59 \$ 10 s/p
66-8880-01N Pink ID F1	UNT EXCL.	Pink	Round	For the amateur of pink tomato, here is a beautiful early variety whose fruits weigh from 170 g to 210 g. Pink ID has an exceptional taste and produces a large quantity of fruits without white heart or apical rot (black spots under the tomato).	16.59 \$ 10 s/p
66-9088-01N Trust F1	UNT EXCL.	Red	Round	The tomato most grown by greenhouse growers. Fruits have a flat globe shape. Continuous yield all season long.	16.59 \$ 10 s/p



Express (Primo)



Broad Windsor



Teggia



Scarlet Runner



Kentucky Blue



Neckargold



Neckarkonigin

Variety Code	Maturity (days)	Form.	Length (cm)	Size	Colour	Variety Description	Price 1 Pkg
Broad bean							
65-5410-01N Express (Primo)	65		16	Medium	Medium green	This very early variety is recommended for freezing.	3.59 \$ 30 s/p
65-5432-01N Broad Windsor	75		15-20	Big	Medium green	Windsor broad bean is superb for family gardens. These wonderful beans have light-green pods, which contain 6–7 large seeds each that shell easily. Fresh or dried, broad beans must be cooked before eating in order to rid them of potentially toxic alkaloids. The young, tender leaves can be eaten raw, or cooked like spinach.	3.59 \$ 30 s/p
65-5432-28N Broad Windsor	75		15-20	Big	Medium green	Available in 125 g/packet.	10.09 \$ 125 g
65-5432-0KN Broad Windsor	75		15-20	Big	Medium green	Available in 1 kilo/packet.	*60.49 \$ 1 kilo
Shell bean							
65-5528-010 Teggia	80		17-20	Big	Red and cream	Teggia is a beautiful red and cream shell bean, 17 cm to 20 cm long pods. It can be picked early as a fresh shell bean, like a lima bean, or left to ripen and dry on the plant to make a supply of beautiful dried beans. Fresh beans have a delicious buttery flavour. Teggia grows on a bushy plant, free of currents and is easier to grow in northern regions than lima beans.	3.59 \$ 50 s/p
Pole bean							
65-5320-010 Kentucky Blue	55		16-18	Medium	Bluish dark	Sweet taste. Quality is superior to all Blue Lake types. Vigorous plants. Productive.	3.59 \$ 50 s/p
65-5320-280 Kentucky Blue	55		16-18	Medium	Bluish dark	Available in 125 g/packet.	10.09 \$ 125 g
65-5305-01N Neckargold	65		23-27	Medium	Yellow	Here is a vigorous yellow pole bean, easy to grow and providing a very good yield throughout the season. Sow 3 seeds in a small hole at the foot of a pole and soon you will be picking nice round pods of about 25 cm without having to bend.	4.59 \$ 50 s/p
65-5310-01N Neckarkonigin	65		23-25	Medium	Green	Here is a vigorous green pole bean, easy to grow. See Nerkargold for characteristics.	4.59 \$ 50 s/p
65-5350-010 Scarlet Runner	65		16-18	Medium	Green	Young pods are edible. Also grown for the beauty of the flowers.	4.59 \$ 50 s/p

BEANS



Rocdor



Sunburst



Gold Rush



Loriot



Royal Burgundy

Variety Code	Maturity (days) ^S	Form.	Length (cm)	Size	Variety Description	Price 1 Pkg
Bush bean - yellow						
65-5105-010 Rocdor	48	TR EXCL.	18	Medium	An extra early European delight. Fine and tender beans. Harvest rapidly so it will not become fibrous.	4.59 \$ 70 s/p
65-5105-500 Rocdor	48	TR EXCL.	18	Medium	Available in 500 seeds/packet.	14.49 \$ 500 s/p
65-5105-0M0 Rocdor	48	TR EXCL.	18	Medium	Available in 5000 seeds/packet.	*70.19 \$ 5000 s/p
65-5125-010 Sunburst	55	TR	13-15	Medium	A commercial variety with outstanding quality, uniformity and yield that is now offered to home gardeners. Concentrated production. Multiple harvests.	3.59 \$ 70 s/p
65-5125-500 Sunburst	55	TR	13-15	Medium	Available in 500 seeds/packet.	10.09 \$ 500 s/p
65-5125-0M0 Sunburst	55	TR	13-15	Medium	Available in 5000 seeds/packet.	*60.49 \$ 5000 s/p
65-5125-01N Sunburst	55	UNT	13-15	Medium	Available in untreated seed.	3.59 \$ 70 s/p
65-5125-50N Sunburst	55	UNT	13-15	Medium	Available in 500 seeds/packet.	10.09 \$ 500 s/p
65-5125-0MN Sunburst	55	UNT	13-15	Medium	Available in 5000 seeds/packet.	*60.49 \$ 5000 s/p
65-5161-01N Gold Rush	58	UNT EXCL.	13-15	Medium	A variety preferred by vegetable growers because of its high yield and quality. Gold Rush is sweet, firm and crunchy.	3.59 \$ 70 s/p
65-5161-28N Gold Rush	58	UNT EXCL.	13-15	Medium	Available in 125 g/packet.	10.09 \$ 125 g
65-5161-0KN Gold Rush	58	UNT EXCL.	13-15	Medium	Available in 1 kilo/packet.	*60.49 \$ 1 kilo
Bush bean - yellow French type						
65-5103-010 Loriot	55	TR EXCL.	10	Fine	French beans, fine and delicate, that produce an abundance of tender, juicy and sweet pods. Replacement for the Serin variety.	4.59 \$ 70 s/p
65-5103-500 Loriot	55	TR EXCL.	10	Fine	Available in 125 g/packet.	14.49 \$ 125 g
65-5103-0M0 Loriot	55	TR EXCL.	10	Fine	Available in 1 kilo/packet.	*70.19 \$ 1 kilo
Bush bean - purple						
65-5280-010 Royal Burgundy	52	TR EXCL.	15-18	Medium	Tender. Stringless. Purple, turning to green when cooked. Unique!.	3.59 \$ 70 s/p
65-5280-280 Royal Burgundy	52	TR EXCL.	15-18	Medium	Available in 125 g/packet.	10.09 \$ 125 g
65-5280-0K0 Royal Burgundy	52	TR EXCL.	15-18	Medium	Available in 1 kilo/packet.	*60.49 \$ 1 kilo



Tendergreen Stringless



Sybaris



Blue Lake



Mascotte Patio Collection



Hawaii

Variety Code	Maturity (days) ^S	Form.	Length (cm)	Size	Variety Description	Price 1 Pkg
Bush bean - green						
65-5253-010 Tendergreen Stringless	49	TR EXCL.	15	Medium	Another popular variety with high, all summer long, productivity of extra meaty pods that stays delicious longer. It has a wonderful taste, fresh from the garden.	3.59 \$ 70 s/p
65-5253-280 Tendergreen Stringless	49	TR EXCL.	15	Medium	Available in 125 g/packet.	10.09 \$ 125 g
65-5253-0K0 Tendergreen Stringless	49	TR EXCL.	15	Medium	Available in 1 kilo/packet.	*60.49 \$ 1 kilo
65-5256-010 Sybaris	55	TR	14	Medium	Dark green, medium-sized bush bean, Sybaris will grow high on the plant, facilitating harvest of clean and straight husks. Excellent performance of quality husks.	3.59 \$ 70 s/p
65-5256-500 Sybaris	55	TR	14	Medium	Available in 500 seeds/packet.	10.09 \$ 500 s/p
65-5256-0M0 Sybaris	55	TR	14	Medium	Available in 5000 seeds/packet.	*60.49 \$ 5000 s/p
65-5256-01N Sybaris	55	UNT	14	Medium	Available in untreated seed.	3.59 \$ 70 s/p
65-5256-50N Sybaris	55	UNT	14	Medium	Available in 500 seeds/packet.	10.09 \$ 500 s/p
65-5256-0MN Sybaris	55	UNT	14	Medium	Available in 5000 seeds/packet.	*60.49 \$ 5000 s/p
65-5226-010 Blue Lake	60	TR EXCL.	15-16	Medium	This bean can be eaten fresh, canned or frozen.	3.59 \$ 70 s/p
Bush beans - green French type						
65-5202-01N Mascotte Patio Collection	50	UNT EXCL.	11-13	Fine	Compact plant ideal for patio containers and window boxes, which can also be grown in garden beds. Beautiful white-blooming time followed by an abundant crop of small, fine, crunchy and good tasting beans. 2014 AAS winner.	3.59 \$ 70 s/p
65-5202-50N Mascotte Patio Collection	50	UNT EXCL.	11-13	Fine	Available in 500 seeds/packet.	10.09 \$ 500 s/p
65-5202-0MN Mascotte Patio Collection	50	UNT EXCL.	11-13	Fine	Available in 5000 seeds/packet.	*80.89 \$ 5000 s/p
65-5206-010 Hawaii	58	TR EXCL.	12-13	Extra fine	Small extra fine bean of beautiful quality. The cordless pods, of a medium green colour, are straight and crispy in the mouth. Barely cooked, it is tender under the tooth. The plant is robust and produces an abundant harvest. Hawaii has its place in every garden.	3.59 \$ 70 s/p
65-5206-500 Hawaii	58	TR EXCL.	12-13	Extra fine	Available in 500 seeds/packet.	10.09 \$ 500 s/p
65-5206-0M0 Hawaii	58	TR EXCL.	12-13	Extra fine	Available in 5000 seeds/packet.	*60.49 \$ 5000 s/p

* The 10% discount is not applicable. Catalogue prices are effective until **June 30, 2022**



Soldier



Babybeet F1



Red Ace F1



Touchstone Gold



Detroit Suprême



Guardsmark (Chioggia)



Avalanche F1



Taurus F1



Mix Organic

Variety Code	Maturity (days)	Form.	Root (shape)	Variety Description	Price 1 Pkg
Beet					
65-0885-01N Soldier	35		-	A beet grown especially for the beauty of its dark red foliage resembling that of the Swiss chard. Harvest leaves when young and add them to your salads for a touch of colour, originality and vitamins.	4.59 \$ 175 s/p
65-0827-010 Babybeet F1	55		Round	The perfect size for baking or steaming whole. At last, here is a real baby beet! Unlike large beets harvested young, Babybeet will remain small, round, smooth and sweet, with a small taproot, all the way to maturity.	4.59 \$ 175 s/p
65-0840-010 Red Ace F1	55		Round	Among all beet varieties available, the productive Red Ace is the most consistently smooth and sweet. The high sugar content makes it a succulent favourite for both cooking and pickling.	3.59 \$ 175 s/p
65-0840-01B Red Ace F1	55		Round	Available in certified organic seed.	5.69 \$ 175 s/p
65-0840-250 Red Ace F1	55		Round	Available in 25 g / packet.	10.09 \$ 25 g
65-0840-25B Red Ace F1	55		Round	Available in 25 g / packet.	11.09 \$ 25 g
65-0800-01B Mix Organic	55-60		Round	For an original assortment, sow rows of this blend of beets. You will harvest a nice selection of red, yellow and red and white striped roots.	5.69 \$ 175 s/p
65-0850-01N Detroit Suprême	60		Round	This highly productive variety is an old time favourite on the market. Dark red in color, nice round and smooth roots with little zoning and good top attachment.	3.59 \$ 175 s/p
65-0850-25N Detroit Suprême	60		Round	Available in 25 g / packet.	10.09 \$ 25 g
65-0887-01B Guardsmark (Chioggia)	60		Oval-Round	An improved version of the well-known Chioggia beet. The same round shape, characteristic white zoning that holds even after cooking and the same distinctive peppery taste. You will select Guardsmark for its uniformity and great vigour.	5.69 \$ 175 s/p
65-0895-01N Avalanche F1	60		Round	Avalanche is a pure white beet that exhibits a mild, sweet taste with a uniform root shape and no reddish tinge, making for more attractive produce. You will rave about the raw eating quality when you will discover there is no earthy beet taste, or any bitter aftertaste. Grow them with gold and red beet for an attractive roots trio. 2015 AAS Winner.	4.59 \$ 175 s/p
65-0880-010 Taurus F1	60		Cylindrical	A nice large smooth, cylindrical and really uniform root, easy to clean and to peel. Ideal for abundant and tasty preserves. When fully grown the root measures 15 to 17 cm long.	5.69 \$ 175 s/p
65-0880-250 Taurus F1	60		Cylindrical	Available in 25 g / packet.	11.09 \$ 25 g
65-0889-01B Touchstone Gold	60		Round	A very nice round root, orange on the exterior and bright yellow inside. This beet has a very sweet and tender taste, a nice shape with little zoning. Perfect for noteworthy pickled beets!	5.69 \$ 175 s/p



Kosaro Y.R. F1



Bronco Y.R. F1



Gunma Y.R. F1



Caraflex Y.R. F1



Lennox F1



Reaction Y.R. F1



Klimaro F1



Melissa Y.R. F1

Variety Code	Maturity (days)	Form.	Colour	Fruit weight (kg)	Variety Description	Price 1 Pkg
Cabbage - Summer						
65-3419-01N Kosaro Y.R. F1	62		Red	0,9-1,4	It presents a well wrapped round and dark red head , very uniform. It has a good tolerance to cracking which allows to keep your cabbages in the garden before harvesting them.	6.79 \$ 50 s/p
65-3548-01N Bronco Y.R. F1	65		Green	1,8-2,2	This mid-early variety will produce high quality cabbage all summer long. Heavy heads: 2 to 2.5 kg. Appealing green and waxy leave. Holds well in the garden. Sweet taste. Very good disease tolerance. The best in its class.	5.69 \$ 50 s/p
Flat Cabbage - Summer						
65-3578-010 Gunma Y.R. F1	85		Green	1,8	Gunma is a flat cabbage with thin leaves that detach themselves very easily. It is perfect for cabbage rolls or original wraps. Raw or cooked, it keeps its surprisingly sweet taste.	6.79 \$ 50 s/p
Cabbage pointed - Summer						
65-3570-01B Caraflex Y.R. F1	63		Green	0,4-1,4	This mini cabbage has an original pointed shape and a great sweet taste with very tender leaves. Coleslaw like no other. To get a 500 g head, reduce the spacing between plants in the row to 20 cm and use a fertilizer without nitrogen.	6.79 \$ 25 s/p
Cabbage - Winter						
65-3620-01B Lennox F1	92		Green	2-2,5	Well known variety from growers because of its sweet taste and tender texture, which is unusual for a winter cabbage. Lennox produces round, solid and well wrapped heads that will store for a long time.	6.79 \$ 50 s/p
65-3623-01B Reaction Y.R. F1	92		Green	2-2,25	A mini winter cabbage that can easily keep for 6 months in a cold storage. Add vitamins to your winter meals. In order to get a nice and firm 500 to 700 g head, reduce the spacing in the row between plants to 20 cm and use a fertilizer without nitrogen.	6.79 \$ 25 s/p
65-3487-01N Klimaro F1	110		Red	2,5-3	A versatile variety, Klimaro can be harvested when small or large. It has a small core and a fantastic internal red colour that will stand well. It has an excellent flavour, particularly suited for coleslaw.	6.79 \$ 50 s/p
Cabbage - Savoy						
65-3030-010 Melissa Y.R. F1	75		Green	1-1,5	This beautiful, dark green and heavy headed Savoy cabbage will surprise you. A great source of nutritive elements.	6.79 \$ 50 s/p



BR 18 F1



Mini Sibsey F1



Diplomat F1



Divino F1



All Season Mix



Fioretto 60 F1



Minuteman F1



Depurple F1



Cheddar F1 Orange



Veronica Y.R. F1 (Romanesco)

Variety Code	Maturity (days)	Form.	Harvest Season	Variety Description	Price 1 Pkg
Broccoli					
65-1407-010 BR 18 F1	75		Spring and fall	An early variety, very compact with a nice medium green dome shaped head. Good heat tolerance.	6.79 \$ 75 s/p
65-1496-01N Mini Sibsey F1	85		Spring-summer-fall	Dark green, stem broccoli. Starts out similar to a regular crown broccoli but after harvesting the first crown, easy-to-harvest tender, and tasty side shoots continue to appear long into the season. Tolerant to warm temperature bolting.	7.89 \$ 75 s/p
65-1472-01N Diplomat F1	87		Summer and fall	A vigorous mid-season broccoli in shades of blue with a nicely domed head. Fill your plate with delicious antioxidants.	4.59 \$ 75 s/p
Brussels sprouts					
65-2844-010 Divino F1	116		Fall	Will produce medium sized sprouts, on a strong and erect plant. The taste will be sweeter if you harvest them after a couple of frosts.	10.09 \$ 50 s/p
Cauliflower					
65-3800-010 All Season Mix	--		Spring and fall	A well-blended mix of selected quality varieties, some chosen for their earliness and others for their lateness, allowing season long harvests. Popular variety for the family garden.	6.79 \$ 50 s/p
65-3875-01N Fioretto 60 F1	60		Spring and fall	Fioretto is a new long-stem cauliflower that you harvest as sticks. It has a sweet taste and a smoother texture than the traditional cauliflower. Each stick weighs between 10 and 20 grams. A new way of growing cauliflower in your vegetable garden.	7.89 \$ 20 s/p
65-3812-010 Minuteman F1	68		Spring and fall	Minuteman is a uniform and early cauliflower very productive and a high quality variety. It produces large, pure white heads well protected by upright leaves. Known for its excellent taste.	7.89 \$ 50 s/p
65-3872-01N Depurple F1	75		Spring-summer-fall	Splendid lavender coloured cauliflower which keeps with cooking. A vitamin-rich curiosity on your plate.	6.79 \$ 20 s/p
65-3869-010 Cheddar F1 Orange	80		Fall	An ideal variety that will add colour to your garden! Produces orange curds that are smooth and well domed. High levels of beta-carotene. For optimal coloration, don't tie the curd.	6.79 \$ 20 s/p
65-3881-01B Veronica Y.R. F1 (Romanesco)	85		Fall	Romanesco type. Lime green pointed heads that show a nice uniformity. An interesting and unusual vegetable to grow.	6.79 \$ 20 s/p



SimplySalad Storm Mix



Black Magic



Darkibor F1

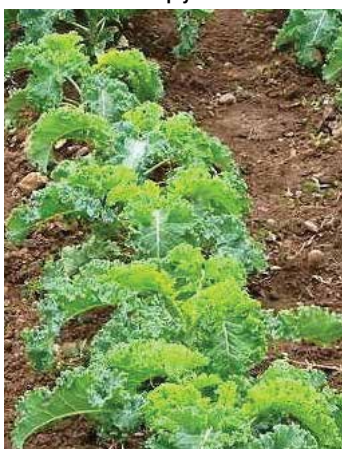

Starbor F1



Redbor F1

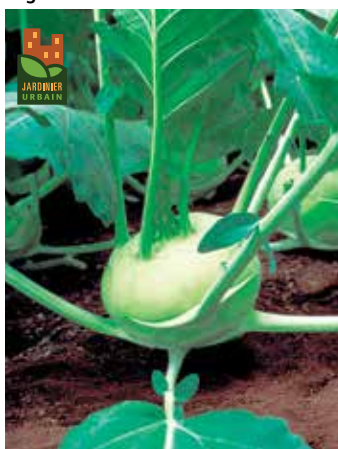

Quickstar F1



Kolibri F1

Variety Code	Maturity (days)	Form.	Colour	Variety Description	Price 1 Pkg
Kale					
65-3133-01N SimplySalad Storm Mix	35		Mixture	Health in a pot. The first all-kale SimplySalad includes an attractive mix of textures and colours including purple, green and blue. This mix will last longer in containers than lettuce and won't bolt. Storm Mix can also be planted in the ground for all-season harvest. Multiple seed coating	7.89 \$ 10 s/p
65-3127-01N Black Magic	45		Dark blue	Rich, very dark blue kale with a rosette plant habit making it easy to harvest. Black Magic has a sweet flavor, a vigorous regrowth and a good uniformity. It also resists bug damage. Throughout the season, new leaves will appear, providing you with a continuous harvest.	6.79 \$ 50 s/p
65-3122-010 Darkibor F1	55		Dark green-blue	Early maturing, easy-growing kale for late summer and fall harvests. Darkibor has upright plant, finely curled leaves and good field holding ability. Richly textured leaves make the best kale chips with extra curls to better hold the seasoning. Delicious snacking!	6.79 \$ 50 s/p
65-3123-010 Starbor F1	55		Dark green-blue	This kale has dark green-blue leaves and produces compact plants that resist yellowing. Delicious steam cooked.	6.79 \$ 50 s/p
65-3105-010 Redbor F1	55		Red	The first available deep red kale with leaves. A medium size, eye catching and productive plant. Used as an ornamental or edible bush in the garden or in the house. Excellent taste in soups.	6.79 \$ 50 s/p
Kohlrabi					
65-3211-010 Quickstar F1	52		Pale green	A nice round, slightly flattened, a pale green root that is smooth. Early variety with an excellent uniformity in shape and maturity. Quickstar is sweet, juicy and rich in vitamins and minerals. Sliced into sticks, it is a nutritious and a flavorful snack for the whole family.	6.79 \$ 50 s/p
65-3252-010 Kolibri F1	55		Purple	A purple exterior with white flesh hybrid produces round-flat bulb with medium tops. Good yield, a very nutritive and flavorful snack for the entire family.	6.79 \$ 50 s/p



Berlin F1



Chantenay Long



Malbec F1



Purple Haze F1



Rainbow F1



Yellowstone



White Satin F1



Mix Colour

Variety Code	Maturity (days)	Form.	Foliage height (cm)	Root Length (cm)	Neck diam. (cm)	Variety Description	Price 1 Pkg
Carrot Berlicum							
65-1885-01N Berlin F1	80		40-45	20-25	4+	Large size Berlicum type with a pointed tip, ideal for storage. Better quality root and very strong tops, Foliage is resistant to disease.	6.79 \$ 1000 s/p
Carrot Chantenay							
65-1894-010 Chantenay Long	70		40-45	23-25	3-5	This variety is very appreciated by customers seeking a Chantenay type carrot that is a tender, crisp, sweet and that keeps all winter long.	5.69 \$ 1000 s/p
65-1894-200 Chantenay Long	70		40-45	23-25	3-5	Available in 10 g packet.	14.49 \$ 10 g (5500 s/p)
Colored carrot							
65-1873-01N Malbec F1	70		40-45	26	2-2,5	Malbec is a red carrot with the best tolerance to bolting on the market. A smooth carrot that averages 26 cm in length, it will add a spark in your vegetable dishes.	7.89 \$ 1000 s/p
65-1880-01N Purple Haze F1	72		40-45	20	2-2,5	Finally, an original carrot that stands out because of its purple exterior colour and orange core. The smooth roots can reach 20 cm in length.	7.89 \$ 1000 s/p
65-1881-01N Rainbow F1	72		40-45	20-25	2-2,5	Intriguing! A variety that produces carrots of different colours: orange, yellow, white and salmon. Good, slightly sweet taste.	7.89 \$ 1000 s/p
65-1877-01B Yellowstone	72		25-30	20-25	2,5-3	Very distinct and unique variety with smooth roots. A productive variety very interesting for the home gardeners.	7.89 \$ 1000 s/p
65-1879-01B White Satin F1	72		40-45	23-25	3	A smooth white, Nantes type carrot with an exceptionally sweet taste. This carrot has an average length and a blunt tip. Excellent yield.	7.89 \$ 1000 s/p
65-1800-01N Mix Colour	65-72		Varié	20-35	2-3	In only one packet you will find a complete selection of flavourful colored carrots that will impress your family and friends. This selection contains white, yellow, salmon, orange, red and purple carrots.	6.79 \$ 1000 s/p



Cellobunch F1



Atlas Round



Caracas F1



Little Finger



Naval F1



Napoli F1



Navarino F1



Improved



Yaya F1

Variety Code	Maturity (days)	Form.	Foliage height (cm)	Root Length (cm)	Neck diam. (cm)	Variety Description	Price 1 Pkg
Carrot Imperator							
65-1824-010 Cellobunch F1	63		35-40	23-28	3-4	Cellobunch is producing a long, uniform and of good caliber carrot that will keep for most of the winter.	5.69 \$ 1000 s/p
65-1824-200 Cellobunch F1	63		35-40	23-28	3-4	Available in 10 g packet.	14.49 \$ 10 g
Carrot Mini							
65-1801-010 Atlas Round	56		20	4-6	2,5	Mini, round "Paris Market" type root with a strong foliage. An uncommon carrot with a very sweet taste. Encrusted seed	5.69 \$ 1000 s/p
65-1875-010 Caracas F1	56		30	10-12	4	Here is a little Chantenay that will bring fun and taste to all your meals. This little conical carrot is sweet, firm and is delicious either raw or cooked. Harvest when the roots reach 10 to 12 cm in length. Encrusted seed	5.69 \$ 1000 s/p
65-1805-01B Little Finger	50		18-20	10	2,5	Sweet and tender! A small, root variety perfect for fresh, preserves or canning baby carrots. Cylindrical deep orange root with smooth skin. Harvest early.	5.69 \$ 1000 s/p
Carrot Nantes							
65-1817-01B Naval F1	55		35-40	20	2-2,5	Here is a Nantes carrot that will allow you to harvest large roots early in the season and will help you maximise the space in your garden. Being a Nantes carrot, its sweet taste is sure to please you.	5.69 \$ 1000 s/p
65-1815-01B Napoli F1	55		30-35	20-22	2,5	Long cylindrical root, very smooth surface, sweet taste. Early and productive variety. Encrusted seed	6.79 \$ 1000 s/p
65-1814-010 Navarino F1	56		30-35	15-18	2,5	Outstanding by its exceptional taste. It is a sweet, refined, European Nantes type hybrid that matures early. It has a smooth and bright skin, is uniform in shape and colour, making it ideal for home gardeners. Encrusted seed	5.69 \$ 1000 s/p
65-1830-01N Improved	62		20-25	18-20	2,5-3	Typically European, this mid-early Nantes type carrot features a uniform shape, smooth skin, tender orange-red flesh and a unique sweet taste.	5.69 \$ 1000 s/p
65-1830-20N Improved	62		20-25	18-20	2,5-3	Available in 10 g packet.	14.49 \$ 10 g
65-1826-01B Yaya F1	62		20-25	16-19	3	Organic Nantes type, smooth, crunchy and very sweet. A little shorter than other Nantes, Yaya redeems this little sin, with a divine taste.	5.69 \$ 1000 s/p

CUCUMBER

Parthenocarpic : Produces a fruit without pollination, isolation required.
Gynocercious : The plant bears only female flowers. A few male seeds are included in the package.
Monoecious : The plant bears both female and male flowers.



Quick Snack F1



Lisboa F1



Sweet Success F1



Bristol F1



Rockingham F1



Peticue F1



Martini F1 White



Diva

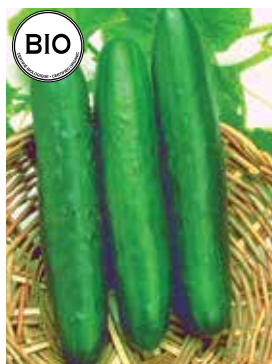

Marketmore 70



Marketmore 76

Variety Code	Maturity (days)	Form.	Fruit size L x D (cm)	Flowering Type	Variety Description	Price 1 Pkg
Slicing Cucumber						
65-4277-01N Quick Snack F1	45		18 x 5	Parthenocarpic	Perfect little mini cucumber to grows inside on a sunny windowsill or counter without a garden. It can also grow outside as a tabletop patio variety. Parthenocarpic variety, which means it will set fruits without a pollinator! Perfectly adapted to the urban grower. Try it at home and the deliciously crisp and sweet taste of this cucumber will charm you.	6.79 \$ 20 s/p
65-4229-01N Lisboa F1	50		18 x 5	Parthenocarpic	A very early cucumber that stands out because of its internal cavity that is free of seeds, making it pleasant to eat and easy to digest. Parthenocarpic type, which means that it should be isolated from the other cucumber varieties in order to give the best possible quality fruits. Impressive yield of two fruits per internode.	7.89 \$ 10 s/p
65-4260-010 Sweet Success F1	50		30-36 x 6	Gynocercious	Similar to the digestible Japanese varieties. Tender, non-bitter taste. Adapted for gardens or greenhouses.	7.89 \$ 10 s/p
65-4214-01N Bristol F1	52		20 x 6	Gynocercious	Great quality early table cucumber! Nice straight and dark green fruits. Plant tolerant to many viruses, powdery mildew and downy mildew. Produces an abundance of crunchy fruits.	6.79 \$ 20 s/p
65-4217-010 Rockingham F1	54		21 x 6	Gynocercious	This cucumber is most appreciated by commercial growers, because it produces nice dark green, smooth and long fruits. Its seed cavity is small with a vigorous and healthy vine. Rockingham is tolerant to powdery mildew. A must to include in your plantings!	6.79 \$ 20 s/p
65-4258-01N Peticue F1	54		18-23 x 6	Monoecious	Short vining slicing cucumbers bred to stay compact. The vines will use only 1/3 space of a standard variety. For the best tasting, crunchy-sweet cues, pick the fruits at 18–23 cm long.	6.79 \$ 10 s/p
65-4266-01N Martini F1 White	55		13-15 x 4	Monoecious	Small cucumber characterized by its white exterior colour and early maturity. Its skin is so thin that the sweet and crunchy fruits do not need to be peeled. The plant, powdery mildew tolerant, has a high and continuous volume of fruits that has no bitterness.	6.79 \$ 10 s/p
65-4232-01N Diva	60		20 x 6	Parthenocarpic	An All America 2002 Selection winner! This productive and high quality variety produces light green, spineless fruits with a smooth skin. Well known in the Middle East it has an unsurpassed flavour. Similar to the Sweet Crunch.	4.59 \$ 20 s/p
65-4238-01B Marketmore 70	63		23 x 6,5	Monoecious	This mid-season class variety offers outstanding fruits. They have a nice dark green color, a nice length and white spines. Excellent flavour and taste.	4.59 \$ 20 s/p
65-4240-010 Marketmore 76	63		23 x 6,5	Monoecious	Very popular open pollination variety for many years now. Still distinguish itself by its productivity, the straight and flavourful fruits.	4.59 \$ 20 s/p

Parthenocarpic : Produces a fruit without pollination, isolation required.
Gynocious : The plant bears only female flowers. A few male seeds are included in the package.
Monoecious : The plant bears both female and male flowers.

CUCUMBER



Lemon



Mouse Melon



Burpless No. 26 F1



English Telegraph



Green Light F1



Magic F1



Mini Munch F1



Petipikel F1



Corentine F1



Salt and Pepper



Eureka F1



Arabian F1

Variety Code	Maturity (days)	Form.	Fruit size L x D (cm)	Flowering Type	Variety Description	Price 1 Pkg
Cucumber Speciality						
65-4278-01B Lemon	70		4 x 6	Monoecious	Attractive heirloom open-pollinated cucumbers that are small and round with lemoncoloured skin. The lime-green flesh is very mild, sweet and never bitter. Very nice for slicing and easy to digest. Vigorous long vine that does well on a trellis or fence. Plants may become quite sprawly, but the fruit production is incredibly vigorous. To lengthen the fruiting period, keep the plants carefully picked so that no fruits are allowed to mature on the vine.	6.79 \$ 20 s/p
65-4280-01N Mouse Melon	70		2 x 3	Gynoecious	Tiny little cucumbers (<i>Melothria scabra</i>) known in Mexico as "sandíita" (little watermelon) and branded here as mouse melons. They have a prominent cucumber flavor with notes of sourness. A nice crunchy addition to summer salads, salsas and pickles. A delicious amusement in your garden.	6.79 \$ 20 s/p
Cucumber English type						
65-4250-010 Burpless No. 26 F1	65		38-40 x 4,6	Monoecious	A grand English-type highly productive cucumber. This variety is very digestible and renowned for its long fruits, tender and sweet flesh with soft skin (no peeling required).	5.69 \$ 20 s/p
65-4250-01B Burpless No. 26 F1	65		38-40 x 4,6	Monoecious	Available in organic seed.	6.79 \$ 20 s/p
65-4254-01N English Telegraph	65		38-45 x 4,5	Monoecious	A digestible European type cucumber. Has a good taste and no bitterness. Open pollinated variety.	4.59 \$ 20 s/p
Cucumber Libanese type						
65-4233-01N Green Light F1	55		7-10 x 3	Parthenocarpic	This mini jewel is an excellent cucumber. It offers a high yield, an attractive fruit, an early maturity and a better flavour than the varieties it has been compared to. For an easy and abundant harvest, it is recommended to stake Green Light or to climb it on a vertical structure. The plant can produce up to 40 thornless fruits. Harvest between 7 cm and 10 cm long for a flavour at its best, without even needing to peel the fruits. A seedless, parthenocarpic variety that does not need to be pollinated. 2020 AAS Winner	4.59 \$ 20 s/p
65-4230-01N Magic F1	55		14-16 x 3	Gynoecious	A Libanese type cucumber without the bitter aftertaste. It produces slightly pointed and smooth fruits with a shiny dark green skin. It can reach from 14 to 16 cm in length.	5.69 \$ 20 s/p
65-4276-01N Mini Munch F1	55		10 x 3	Gynoecious	Delicious little parthenocarpic cucumber to be grown in a container or on a trellis. Tons of tasty, crunchy fruits for great salads or snacks. No need to peel the fruits, the skin is tender and it has a seedless interior. Productive even in cool conditions.	11.09 \$ 10 s/p
Cucumber Pickling						
65-4420-01N Petipikel F1	45		8-13	Monoecious	Petipikel is a short vining bush pickle cucumber that has been bred to stay compact. Its vines reach half the size of other regular pickles, which is space efficient for your garden. For best results, the fruits should be harvested at 8-13 cm long for best results.	6.79 \$ 20 s/p
65-4477-010 Corentine F1	50		10-12 x 2,5	Gynoecious	Corentine is a smooth pickling cucumber combining good early yield with excellent firmness. The fruits have a perfect shape and a nice dark green colour.	5.69 \$ 20 s/p
65-4480-01N Salt and Pepper	50		7-12 x 2,5	Gynoecious	White-skinned pickling cucumber with Powdery Mildew tolerance. Eye-catching colour and excellent flavour. You won't need to add salt and pepper to this unique miniature cucumber. It has just the right amount of natural flavour that is phenomenal. Ideal for pickling or snacking.	5.69 \$ 20 s/p
65-4424-01N Eureka F1	55		10-12 x 2,5	Monoecious	Outstanding variety because of its compact plant and high tolerance to diseases. Produces dark green fruit, similar to small slicers. Very productive. An appealing and flavourful fruit.	3.59 \$ 20 s/p
65-4423-010 Arabian F1	55		10-12 x 2,5	Gynoecious	Short vine variety, dark green in color with good length. To be eaten fresh or for pickling.	3.59 \$ 20 s/p

SWEET CORN - BICOLOUR



Fastlane F1



Bon Jour F1



Nirvana F1



American Dream F1

Variety Code	Maturity (days)	Form.	Cob length (cm)	Number of rows	Variety Description	Price 1 Pkg
Sweet corn - Bicolour SE sweet taste						
65-1127-01N Fast Lane F1	59		18-20	12-14	An early sweet corn variety with good size cobs. Sweet and tender, it is easy to pick and doesn't need to be isolated.	5.69 \$ 85 s/p
65-1127-50N Fast Lane F1	59		18-20	12-14	Available in 500 seeds/packet.	14.49 \$ 500 s/p
65-1127-0MN Fast Lane F1	59		18-20	12-14	Available in 5000 seeds/packet.	*91.69 \$ 5000 s/p
65-1128-01N Bon Jour F1	62		20	14-16	This early sweet corn holds beautiful ears with small sweet and tender kernels. Has an excellent yield. This variety doesn't need to be isolated.	5.69 \$ 85 s/p
65-1128-50N Bon Jour F1	62		20	16	Available in 500 seeds/packet.	14.49 \$ 500 s/p
65-1128-0MN Bon Jour F1	62		20	16	Available in 5000 seeds/packet.	*91.69 \$ 5000 s/p
Sweet corn - Bicolor SH2 extra sweet (isolation required)						
65-1156-010 Nirvana F1	75		20	16	This variety is without a doubt the sweetest and most tender you ever tasted. Its small kernels explode in your mouth. The advantages of this variety are: field holding and shelf life. It will still be good and tasty for your corn-husking party expected in the next few days.	7.89 \$ 85 s/p
65-1156-500 Nirvana F1	75		20	16	Available in 500 seeds/packet.	22.09 \$ 500 s/p
65-1156-0M0 Nirvana F1	75		20	16	Available in 5000 seeds/packet.	*161.49 \$ 5000 s/p
65-1163-010 American Dream F1	77		20	16-18	There is a good reason why AAS Judges selected American Dream as their top trial choice! With its excellent germination, very tender, super-sweet kernels, this newbie will make a great addition to the home garden. American Dream produces vigorous, healthy plants with cobs that have good tip fill of bicoloured kernels. Perfect fresh, roasted, grilled, canned or frozen. Needs to be isolated from other sweet corn.	10.09 \$ 85 s/p
65-1163-500 American Dream F1	77		20	16-18	Available in 500 seeds/packet.	30.69 \$ 500 s/p
65-1163-0M0 American Dream F1	77		20	16-18	Available in 5000 seeds/packet.	*161.49 \$ 5000 s/p



Sweetness F1



Profit F1



Allure F1



Providence F1

Variety Code	Maturity (days)	Form.	Cob length (cm)	Number of rows	Variety Description	Price 1 Pkg
Sweet corn - Bicolour SESH2 very sweet						
65-1118-010 Sweetness F1	67		20	16	Sweetness is the sweetest early corn available on the market. Very vigorous, it will give you an impressive yield, with usually two ears per plant. It's crispy and very sweet taste will surely attract your attention.	5.69 \$ 85 s/p
65-1118-500 Sweetness F1	67		20	16	Available in 500 seeds/packet.	14.49 \$ 500 s/p
65-1118-0M0 Sweetness F1	67		20	16	Available in 5000 seeds/packet.	*113.19 \$ 5000 s/p
65-1118-01N Sweetness F1	67		20	16	Available in untreated seed.	5.69 \$ 85 s/p
65-1118-50N Sweetness F1	67		20	16	Available in 500 seeds/packet.	14.49 \$ 500 s/p
65-1118-0MN Sweetness F1	67		20	16	Available in 5000 seeds/packet.	*113.19 \$ 5000 s/p
65-1150-010 Profit F1	72		20	14-16	It will dazzle you! Very good ear quality. Early producer with 16 rows of delicious and sweet kernels.	5.69 \$ 85 s/p
65-1150-500 Profit F1	72		20	14-16	Available in 500 seeds/packet.	14.49 \$ 500 s/p
65-1150-0M0 Profit F1	72		20	14-16	Available in 5000 seeds/packet.	*113.19 \$ 5000 s/p
65-1150-01N Profit F1	72		20	14-16	Available in untreated seed.	5.69 \$ 85 s/p
65-1150-50N Profit F1	72		20	14-16	Available in 500 seeds/packet.	14.49 \$ 500 s/p
65-1150-0MN Profit F1	72		20	14-16	Available in 5000 seeds/packet.	*113.19 \$ 5000 s/p
65-1175-01B Allure F1	74		20-21	16	The Allure is a recent discovery which continues to impress. It produces a well-covered and attractive cob of great quality with a great classic corn taste. The plant is very solid.	10.09 \$ 85 s/p
65-1175-50B Allure F1	74		20-21	16	Available in 500 seeds/packet.	30.69 \$ 500 s/p
65-1175-0MB Allure F1	74		20-21	16	Available in 5000 seeds/packet.	*113.19 \$ 5000 s/p
65-1190-010 Providence F1	79		20	18	Remarkable! This outstanding mid-season bicolor is a variety of the 'Triplesweet' type, 75% sugar enhanced (Se) and 25% super sweet (Sh2) kernels.	5.69 \$ 85 s/p
65-1190-500 Providence F1	79		20	18	Available in 500 seeds/packet.	14.49 \$ 500 s/p
65-1190-0M0 Providence F1	79		20	18	Available in 5000 seeds/packet.	*113.19 \$ 5000 s/p

SWEET CORN - YELLOW



Equinox F1



Cafe F1

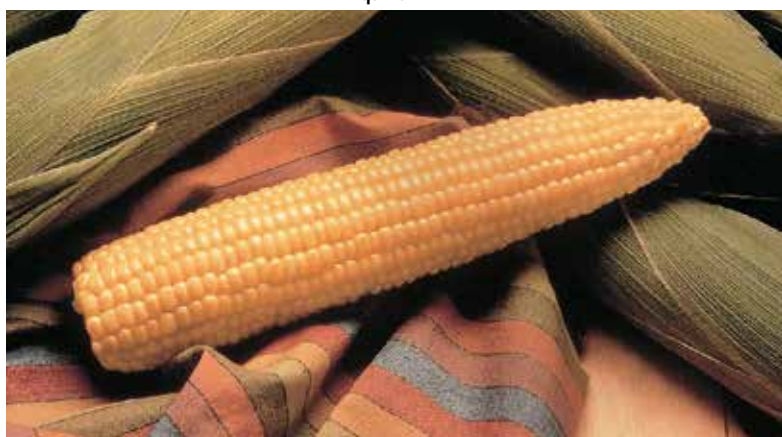

Honey Select F1



White Cloud F1

Variety Code	Maturity (days) ^S	Form.	Cob length (cm)	Number of rows	Variety Description	Price 1 Pkg
Sweet corn - Yellow SH2 extra sweet (isolation required)						
65-1388-010 Equinox F1	72		19	16-18	Early yellow corn, well filled and well protected by an attractive foliage and an excellent seedling vigour. But most importantly, Equinox offers an outstanding taste and out of the ordinary tenderness for its maturity. Must be isolated. Replaces the SC1336 variety.	7.89 \$ 85 s/p
65-1388-500 Equinox F1	72		19	16-18	Available in 500 seeds/packet.	22.09 \$ 500 s/p
65-1388-0M0 Equinox F1	72		19	16-18	Available in 5000 seeds/packet.	*161.49 \$ 5000 s/p
Sweet corn - Yellow SESH2 very sweet						
65-1322-010 Cafe F1	68		20	14-16	Cafe is the first yellow corn of this category to be as early. You can now appreciate a yellow, sweet and tender corn at the beginning of the season.	7.89 \$ 85 s/p
65-1322-500 Cafe F1	68		20	14-16	Available in 500 seeds/packet.	22.09 \$ 500 s/p
65-1322-0M0 Cafe F1	68		20	14-16	Available in 5000 seeds/packet.	*113.19 \$ 5000 s/p
65-1340-010 Honey Select F1	78		20	16	Honey Select is a triple sweet variety that contains 75% sugar enhanced (Se) and 25% super sweet (Sh2) kernels. Very nice good tasting yellow variety.	5.69 \$ 85 s/p
65-1340-500 Honey Select F1	78		20	16	Available in 500 seeds/packet.	14.49 \$ 500 s/p
65-1340-0M0 Honey Select F1	78		20	16	Available in 5000 seeds/packet.	*91.69 \$ 5000 s/p
Corn - Popcorn						
65-1399-010 White Cloud F1	95		-	-	Best early variety with a very high yield. This variety of white popcorn is the one that is best adapted for our northern regions. Ears are well filled with popcorn kernels that are slightly pointed and silvery. Will give pure white popcorn kernels, up to 30 times their original size.	3.59 \$ 85 s/p



Patio Baby F1 Patio Collection



Fairy Tale F1



Purple Shine F1

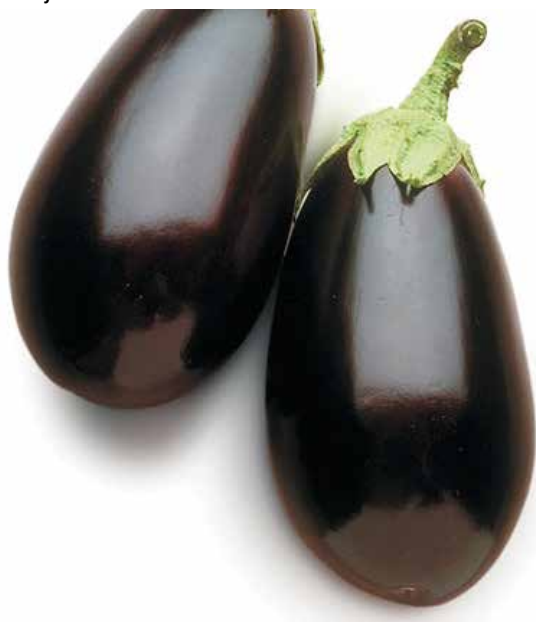

Night Shadow F1



Traviata F1

Variety Code	Maturity (days)	Form.	Fruit Shape	Fruit size L x D (cm)	Colour	Variety Description	Price 1 Pkg
65-0620-01N Patio Baby F1 Patio Collection	45		Oval	10-12 x 7-8	Dark purple	Unique, high yielding, almost thornless, compact variety that produces baby size eggplants very early with a wide harvest window. Suited for growing in containers or in the garden.	6.79 \$ 20 s/p
65-0624-01N Fairy Tale F1	58		Oval Elongated	10 x 4	Violet/ white stripes	A variety with an original touch for your garden! Dwarf plants produce miniature purple with white stripes fruits with an elongated oval shape. They can be harvested at all stages of maturity.	5.69 \$ 20 s/p
65-0630-01N Purple Shine F1	65		Elongated	30 x 4	Purple	Italian type, elongated, purple eggplant that grows on an erect and sturdy plant. Since Purple Shine is seedless, you will enjoy having it as a side dish or cooking it in your favorite recipes.	6.79 \$ 20 s/p
65-0617-01N Night Shadow F1	68		Oval	20 x 12	Dark purple	It is deep purple in color with an oval shape. It has a 12 cm diameter and is 20 cm long.	4.59 \$ 20 s/p
65-0629-01B Traviata F1	70		Oval Elongated	20 x 11	Dark purple	A vigorous, without thorn, plant producing fruits of uniform size throughout the season. Good productivity.	5.69 \$ 20 s/p

LEAFY VEGETABLES



Bali Red



Silverado



Celebration Multicolour











Cress Extra Curled Alenois



Indigo F1



Sioux F1

Variety Code	Maturity (days) 	Form.	Foliage color	Variety Description	Price 1 Pkg
Swiss chard					
65-1064-01N Bali Red	58		Dark green	Superb swiss chard with bright red petioles.	4.59 \$ 125 s/p
65-1012-01N Silverado	58		Dark green	An excellent source of vitamin A and C, iron and folic acid, Swiss chard is perfect as a side dish with meat, poultry or fish. Silverado has a dark green leaf and a white stalk and is slow to bolt even in hot weather.	5.69 \$ 125 s/p
65-1054-01N Celebration Multicolour	62		Dark green	High percentage of red, yellow, orange and pink petioles, very little of white. Ideal to add colours in your recipes.	5.69 \$ 125 s/p
Chicory - Italian Raddichio					
65-2235-01N Indigo F1	70 		Red	One of the earliest varieties of radicchio on the market. Radicchio is a vegetable that is growing in popularity among home gardeners. Indigo is outstanding for its great uniformity and quality, it produces good-size, round, dense heads that are bright deep red with very white veins. This super yielder will add color and zest to your salads.	10.09 \$ 50 s/p
Cress					
65-4810-01N Cress Extra Curled Alenois	20		Green	Vigorous selection with a spicy flavour. Best if harvested at the 3-4 leaf stage.	3.59 \$ 375 s/p
Spinach					
65-5035-010 Sioux F1	50		Dark green	Versatile, semi-quick growing spinach variety with a proven track record in hot conditions. The dark green leaves are thick but flexible and semi-blistered. Perfect for growing both baby spinach and mature leaves. Replaces the Stanton variety.	4.59 \$ 350 s/p



White Jewel F1



Joi Choi



Bilko Y.R. F1



Scansie F1



Match



Bellezia



Roquette



Wasabi

Variety Code	Maturity (days)	Form.	Foliage color	Variety Description	Price 1 Pkg
Oriental vegetables					
65-2695-010 White Jewel F1	35		Dark green	Dwarf Pak Choi with compact and tight body. Very uniform with dark green, wrinkly leaves and thick white stems. White Jewel will grow about 10-12 cm tall and has high heat and cold tolerance. Add it to your sautés or have it as a side dish. Coated seed	6.79 \$ 50 s/p
65-2690-010 Joi Choi F1	50		Green	Pak Choi type, non-bolting hybrid and productive variety. Vigorous plants of rapid growth, with nice long white stems and dark green foliage. Regularly used in Chinese cuisine. This cabbage will do well when cultivated during the summer or under dry conditions.	3.59 \$ 50 s/p
Oriental vegetables - Chinese cabbage					
65-2617-01B Bilko Y.R. F1	60		Green	A large and heavy light green cabbage. It can weigh up to 2.5 kg.	6.79 \$ 50 s/p
65-2606-010 Scansie F1	65		Purple red	A special bright purple-red Chinese cabbage! It produces heads of 1.2 kg to 1.5 kg in size coloured all the way to the heart. Good tolerance to tip burn and bolting.	10.09 \$ 25 s/p
Corn Salad					
65-5812-010 Match	45		Green	Flexibility and great quality of leaves. Match is an easy-to-grow crop that can produce a good harvest over a long period. This modern variety is also slow to have the leaves turn yellow. Replaces the Valgros variety.	3.59 \$ 200 s/p
Rocket (Arugula)					
67-8123-01B Bellizia	30-40		Dark green	Arugula Bellezia is a beautiful variety with an impressive tolerance to downy mildew. Striking dark green and highly serragated leaves give Bellezia an elegant look. Excellent bolting tolerance, and excellent shelf-life.	5.69 \$ 100 s/p
67-8110-01N Rocket	30-40		Green	Cultivated arugula, with a rich and peppery taste, without being too spicy. Good tolerance to bolting.	5.69 \$ 100 s/p
67-8104-01N Wasabi	30-40		Dark green	Wasabi rocket is a new variety of small young shoots that will tickle your nose, such as the mustard bearing the same name. Its small leaves, with delicate serrated edges, are at the same time tender and spicy. It will give a «punch» to your recipes.	5.69 \$ 100 s/p

LETTUCE



Buttercrunch

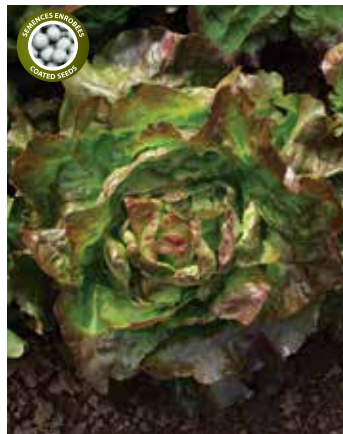

Edox Red

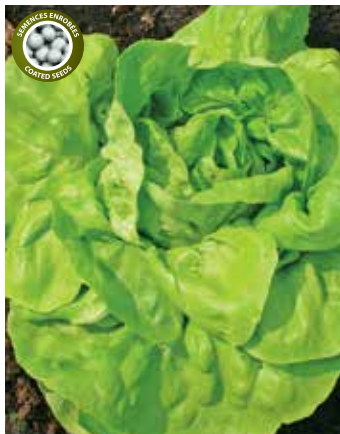

Rhapsody Green



Eazy Leaf Bellevue Red

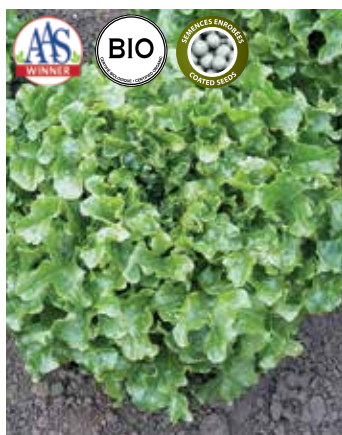

Bauer Green



Grand Rapids Green

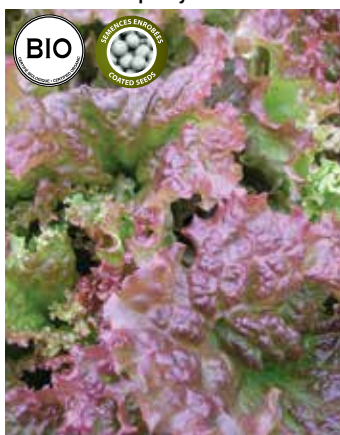

New Red Fire Red

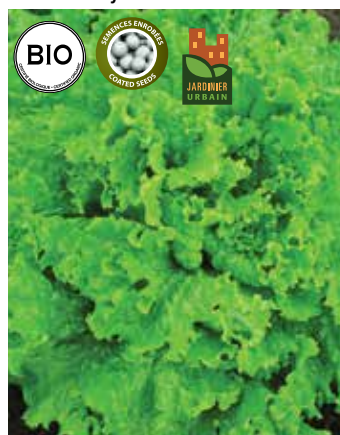

Bergam's Green

Variety Code	Maturity (days)	Form.	Variety Description	Price 1 Pkg
Lettuce Butterhead				
65-5707-01B Buttercrunch	55		Popular variety. Crunchy, tasty leaves. Tolerates heat. Slow to bolt. A heavy medium-size head.	3.59 \$ 600 s/p
65-5734-010 Edox Red	55		A nice Butterhead lettuce in attractive colours of green and red. Its delicate leaves with a subtle flavour make a lovely presentation. An easy to grow lettuce all season long. Coated seed	4.59 \$ 200 s/p
65-5706-01N Rhapsody Green	55		A nice early lettuce with dark green, glossy, mouth-watering leaves. This fresh and tasty variety is tolerant to tip burn. A perfect choice for the garden. Coated seed	6.79 \$ 200 s/p
Lettuce - Oak Leaf				
65-5645-01B Eazy Leaf Bellevue Red	55		Dark-red oak-leaf lettuce with a smooth texture and a pleasant sweet taste. Harvested as baby leaves or at its full maturity, Bellevue embellishes any salad. Late bolting and tolerance to downy mildew. Maturity: Baby-25 days / Full-55 days. Coated seed	5.69 \$ 25 s/p
65-5639-01B Bauer Green	55		Bauer will please with its darker green colour and nicely uniform compact size that can be grown almost anywhere; in-ground, containers, or window boxes. Harvest at the baby leaf stage or grow into the rosette-shaped full-sized head. The dense heads produce a plethora of sweet, crisp sturdy leaves. 2022 All America Selection Winner. Coated seed	4.59 \$ 200 s/p
Lettuce - leaf				
65-5615-01N Grand Rapids Green	55		Everyone's favourite. This is the best-known loose-leaf lettuce variety. The medium-green, frilled leaves are tender and crisp; the plant is vigorous and disease-resistant.	3.59 \$ 600 s/p
65-5615-20N Grand Rapids Green	55		Available in 10 g/packet.	7.89 \$ 10 g
65-5667-01B New Red Fire Red	55		A feast for the eyes as well as for the palate. The most ruby red loose-leaf variety in our selection. She produces a beautiful loose-leaf head, crisp and sweet, with proven bolt resistance. This lettuce can be grown in both cool and warm weather conditions without becoming bitter. Coated seed	3.59 \$ 200 s/p
65-5619-01B Bergam's Green	58		Large size leaf lettuce, that is just a bit later than most other varieties. Slow to bolt and tolerant to tip burn, she will soon become your best variety. Coated seed	4.59 \$ 200 s/p



Mesclun Mix Improved

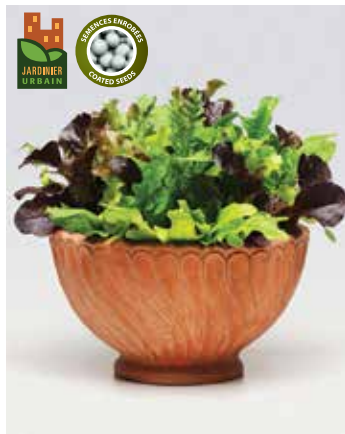

SimplySalad Alfresco



SimplySalad City Garden



SimplySalad Wonder Wok



Pomegranate Crunch red

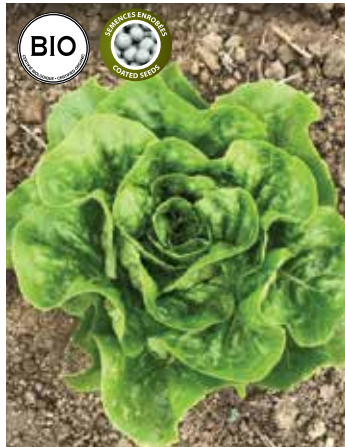

Xalbadora Green

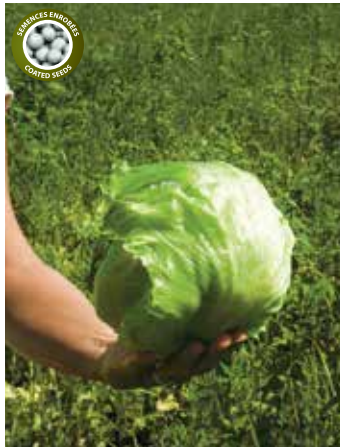

PYB 7101



Paris Island Select

Variety Code	Maturity (days)	Form.	Variety Description	Price 1 Pkg
Mesclun Lettuce				
65-5601-01B Mesclun Mix Improved	28		This European approach to growing salad greens offers you a choice mix of the best sweet lettuces and tangy, tender greens in just the right proportions. Gather leaves when young for delectable flavour!	3.59 \$ 600 s/p
65-5602-01N SimplySalad Alfresco	30		A blend of lettuces, arugula, chicory and radicchio. A taste of the Mediterranean. This blend takes around 30 days to reach maturity and can be cut up to three times. Coated seed	7.89 \$ 25 s/p
65-5603-01N SimplySalad City Garden	30		Our most traditional blend of mild lettuces. This blend takes around 30 days to reach maturity and can be cut up to three times. Coated seed	7.89 \$ 25 s/p
65-5605-01N SimplySalad Wonder Wok	30		Here is a new mix of mesclun made of Asian greens such as mustards, kale and bok choy. This variety combined in a multi-species pellet produces a well-balanced salad mix with only one sowing. Coated seed	7.89 \$ 25 s/p
Lettuce - Mini romaine				
65-5770-01B Pomegranate Crunch red	55		Here is a mini romaine lettuce of a bright poppy red color. Pomegranate Crunch reaches only about 15 cm in height, but its compact and dense head will surprise you by the high yield of leaves. The taste is slightly sweet and the texture smooth and crispy. To be tried as a mix with the Eazyleaf varieties! Coated seed	7.89 \$ 25 s/p
65-5776-01B Xalbadora Green	55		Mini romaine with high leaf count. Xalbadora performs great against tip burn and has a wide adaptability. Coated seed	7.89 \$ 25 s/p
Lettuce - Crisphead				
65-5765-010 PYB 7101	90		A large size Iceberg type lettuce, crisp and delicious. Presented last year to our commercial growers, it was an immediate popular choice because of its good tolerance to heat and diseases. Guaranteed quality. Coated seed	3.59 \$ 200 s/p
Lettuce - Romaine				
65-5787-01B Paris Island Select	75		Improved selection, with very attractive heads that have a superior dark green colour and contrasting, blanched interior. It features a crispy Savoy leaf texture and sweet, mild flavour. A delight!	3.59 \$ 600 s/p



Garoy



Imperial Star



Guelph Millenium F1



Tango



Balena F1



Golden Husk



Little Lantern



Picador F1



Conservor F1



Purple Top White Globe

Variety Code	Maturity (days)	Form.	Variety Description	Price 1 Pkg
Peanut				
65-0110-01N Garoy	100		This variety produces pods slightly smaller than those of regular varieties but they are of the finest quality. Flower stems drop to the ground and develop clusters of nuts, under the ground surface.	5.69 \$ 50 s/p
65-0110-28N Garoy	100		Available in 125 g/packet.	14.49 \$ 125 g
Artichoke				
65-0212-01N Imperial Star	120		This variety produces pods slightly smaller than those of regular varieties but they are of the finest quality. Flower stems drop to the ground and develop clusters of nuts, under the ground surface.	11.09 \$ 20 s/p
Asparagus				
65-0456-01N Guelph Millenium F1	Perennial		Variety developed by the University of Guelph in Ontario. It produces very uniform and 100% male spears. Good tolerance to cold. This variety has shown the highest yields over the years.	4.59 \$ 20 s/p
Celery				
65-2035-01B Tango	90		A superb variety of celery in an apple green colour. Its stalks are smooth and crunchy with no bitter taste.	7.89 \$ 150 s/p
Celeriac				
65-2110-01B Balena F1	105		Balena has a round, very white and smooth root. Good tolerance to bolting. It will keep very well for a long period, in cold storage.	6.79 \$ 50 s/p
Ground Cherry				
65-9297-01N Golden Husk	65		Small sweet fruit, recommended for jams.	4.59 \$ 40 s/p
65-9296-01N Little Lantern	70		Smaller, more compact variety of ground cherry, well suited for containers. Smaller fruits (11-14 mm) with lightly colored husks. Good ramification and short internode spaces.	7.89 \$ 20 s/p
French Shallot (Seeds)				
65-6783-010 Picador F1	88		A lovely round, brownish-pink French shallot. Its distinctive flavour makes it a choice condiment. Encrusted seed	6.79 \$ 100 s/p
65-6789-01B Conservor F1	90		An early variety with great yield potential, Conservor is easy to grow from seed. Elongated pink-brown exterior bulb with a nice pale pink flesh. It has a length of 5 to 7 cm and is easy to peel. Quite a flavorful shallot, be cooked or raw.	6.79 \$ 100 s/p
Turnip				
65-6420-01B Purple Top White Globe	57		Popular variety. Round roots are 7.5 to 10 cm in diameter. Attractive white and violet colour. Flesh is white, mild and crunchy. Delicious!	3.59 \$ 275 s/p



Bella Luna F1



Elisa F1



Albion F1



Lancelot



Bandit



Clancy Red F1



Giant Victoria



Laurentien Thomson



Mammouth Sandwich



Karikachi No.3 F1

Variety Code	Maturity (days)	Form.	Variety Description	Price 1 Pkg
Japanese Turnip				
65-6410-01N Bella Luna F1	40		Shiny, pure white, Japanese turnip that can be harvested at a small size or it can hold until medium size (3.5 to 6 cm). Very good flavor, even if eaten raw.	3.59 \$ 275 s/p
Okra				
65-6811-010 Elisa F1	58		For the okra amateur. Best adapted to our northern climate, Elisa produces fruits 9-15 cm in length, with very few seeds, and will not become fibrous. Elisa is early and more productive than other okra varieties.	7.89 \$ 25 s/p
Parsnip				
65-7043-01N Albion F1	115		Early parsnip. Albion produces nice, white roots with a sweet taste. Its shallow collar makes it easy to clean.	3.59 \$ 200 s/p
Leek				
65-7615-01N Lancelot	90		Lancelot is the ideal leek for all your fall dishes. With its bluish and erect foliage, Lancelot produces white stalks that can reach up to 30 cm in length. Lancelot can also be sown tight for a summer harvest of small, tender and juicy leeks.	4.59 \$ 165 s/p
65-7693-01B Bandit	118		Sturdy winter harvest leek. Late to bolt, will remain in good condition for a long time in your garden and can be stored.	6.79 \$ 165 s/p
Potato				
65-7905-01N Clancy Red F1	90-110		Our first potato from seed! The sterile seed eliminates the potential of introducing disease to the garden, is easier to store and will keep longer than potato tubers. Clancy produces compact and healthy dark green plants with blue flowers. Resulting spuds are a mix ranging from red to rose-blush skin tones with flesh of creamy white and yellow. Good texture and flavour (a happy medium between a yellow-skinned potato and a Russet), ideal for mashing or boiling. Start as transplants. Winner of AAS 2019. Coated seed	11.09 \$ 50 s/p
Rhubarb				
65-8410-01N Giant Victoria	Perennial		A variety with great development, very productive, which offers large petioles with green flesh, of very good taste quality. Sowing April-May or August-September for a first harvest 2 years later.	5.69 \$ 50 s/p
Rutabaga				
65-6475-01N Laurentien Thomson	85		A round purplish root with a great taste for all your slow-cooked recipes. Long storage life if kept in a cool place.	3.59 \$ 275 s/p
Salsify				
65-8620-01N Mammouth Sandwich	150		Conical, cream-white roots. They add an oyster taste to soups.	4.59 \$ 125 s/p
Soya Edamame				
65-2670-01N Karikachi No.3 F1	90		A soybean rich in isoflavones, a chemical that helps prevent certain types of cancer. Just like all other soy plant, it requires a well-drained soil heated at 15°C when seeding and in full sun. Harvest when the pods are plump and still bright green. Cook beans in salted boiling water for 5 minutes and add to your salads and stir-fries.	4.59 \$ 50 s/p

MELON



Sugar Cube F1



Magnifisweet F1



Golden Crown F1



Yellow Baby F1 Jaune



Stargazer F1 Rouge



Amarillo F1 Jaune



Cracker Jack F1



Serval F1 Rouge (mini)



Tyrion F1 (Mini)



Ace F1



Honeycomb F1

Variety Code	Maturity (days) ^T	Form.	Fruit Weight (kg)	Variety Description	Price 1 Pkg
Melon - Cantaloupe					
65-5902-01N Sugar Cube F1	68	UNT EXCL.	0,7-1,7	Sugar Cube is a small 1 kg melon with big taste! Its deep orange flesh, amazing sugar content (14% Brix) and incredible taste make it a must for single servings. A real treat in the garden.	6.79 \$ 15 s/p
65-5930-010 Magnifisweet F1	74	TR EXCL.	1,8-2,2	This variety is characterized by a high yield and super flavour. Its slightly netted, deeply ribbed fruits have very sweet, thick salmon-orange flesh. What a winner!	6.79 \$ 20 s/p
Watermelon - seeded					
65-6010-01N Golden Crown F1	68	UNT EXCL.	2-2,6	Fruit is 16 to 17 cm in diameter. External peel is golden yellow. Flesh is intense red and very sweet, with seeds. Ideal for regions with a short growing season. Compact plants.	11.09 \$ 20 s/p
65-6020-01N Yellow Baby F1	70	UNT EXCL.	2,5-3,5	Seeded yellow watermelon with such a sweet and crispy flesh that you won't be able to stop eating it! Shows a good tolerance to cracking. A nice alternative to red watermelons.	6.79 \$ 20 s/p
65-6049-010 Stargazer F1 Red	85	TR EXCL.	11-12	Stargazer is like a big old-fashioned watermelon, crispy and sweet, but with a more uniform shape and weight. It has elongated fruits that can weigh between 11 and 12 kg and a rind with wide dark green stripes. Everything you need when the summer is hot.	7.89 \$ 15 s/p
Watermelon - seedless					
65-6019-010 Amarillo F1 Yellow	75	TR EXCL.	6,5-7	Amarillo is a nice round melon, medium green with pale green stripes, with a crisp and sweet yellow flesh. It is recommended that seedless varieties be transplanted, rather than direct seeding. Pollinator plant required.	16.59 \$ 10 s/p
65-6044-010 Cracker Jack F1	78	TR EXCL.	6,8-8,6	A big beautiful early seedless watermelon. It grows with great vigour and is tolerant to several diseases. This is the variety to try to have an abundant production of red melons with firm flesh and a sweet taste. Replace the Road Trip F1 variety. Pollinator plant required.	16.59 \$ 10 s/p
65-6054-010 Serval F1 Red (mini)	85	TR EXCL.	1.8-2.7	Serval is a mini seedless watermelon that reaches about 1.8-2.8 kg in weight. The red flesh is sweet and crispy. At last a watermelon that you can eat in a decent amount of time and that doesn't take all the space in the refrigerator. Pollinator plant required.	16.59 \$ 10 s/p
65-6057-01N Micro Tyrion F1	85	UNT EXCL.	1	Seedless micro watermelon of about 1 kg. Its rind is black and smooth, and its red flesh is sweet and crispy. A big pleasure in the vegetable garden. Pollinator plant required.	16.59 \$ 10 s/p
Watermelon pollinator					
65-6098-010 Ace F1	70	TR EXCL.	----	This variety was developed as a non-harvest pollinator for seedless watermelon. It produces long, thin, very sturdy vines with small leaves. The plant habit is ideal as it brings the pollinator into close proximity with the seedless melon. It blooms profusely, thus providing an abundance of pollen that will ensure a good harvest. P.S. In order to insure a good pollination, it is essential to plant in your garden one plant of pollinator Ace for every two (2) seedless watermelon plants.	6.79 \$ 5 s/p
Melon - Honeydew					
65-5947-010 Honeycomb F1	75	TR EXCL.	3-3,5	Treat yourself to this early heavy fruit melon. Soft skin, aromatic lime green flesh.	7.89 \$ 10 s/p

ONION & BUNCHING ONION SEEDS



Variety Code	Maturity (days)	Form.	Variety Description	Price 1 Pkg
Echalion				
65-6798-01N Creme Brulee F1	90		First ever echalion to become an All America Selection Winner. An echalion is a cross between an onion and a French shallot, offering the perfect combination of yield and flavour. Easy to grow and delicious to cook and taste.	6.79 \$ 100 s/p
Bunching onion				
65-6720-01B Parade	65		Superb selection with a long, white, non-bulbous shaft. Stem is more bluish green. Cleans easily. High yield variety. Coated seed	3.59 \$ 200 s/p
65-6738-010 Red Baron F1	65		Here is a superb selection with a long dark red non-bulbous shaft. Good zesty flavour.	3.59 \$ 200 s/p
Spanish Onion				
65-6673-010 White Wing F1	108		White Wing is a pure white onion with excellent firmness and good skin retention. It has the potential for big size bulb, especially from transplant. Coated seed	6.79 \$ 165 s/p
65-6668-010 Kelsae Sweet Giant	110		Ultra large onion. Firm and heavy onion with a sweet and tasty flesh. Keeps for a short period. Something different for the home gardener.	10.09 \$ 165 s/p
65-6649-010 Dawson F1	112		Large size, early Spanish onion. Its small neck closes well for a good storage of the bulbs. Coated seed	5.69 \$ 165 s/p
65-6652-01N Delgado F1	120		Delgado has an even, very firm and round bulb. A late bloom that can be stored for many months.	6.79 \$ 165 s/p
Yellow onion				
65-6613-010 Ridge Line F1	100		Ridge Line features a good balance of earliness, size and storage. This mid-early onion is globe shaped, mostly jumbo sizing and shows a good dark skin. Ridge Line adapts well for transplants as well as direct seeding. It has intermediate resistance to pink roots and basal rot. Necks are medium to small with excellent curing for long-term storage. A quality addition to the garden. Coated seed	5.69 \$ 165 s/p
65-6619-01N Lasalle F1	100		A dark brown onion, Lasalle will keep its skin well and can be stored up to eight (8) months under good conditions. With sufficient space to grow, the percentage of big caliber is high.	5.69 \$ 165 s/p
Pink onion				
65-6681-010 Blush F1	105		Unique pink specialty onion! Blush has mostly jumbo size bulbs, is easy to grow and store with its thick and strong skin. Once cut, it shows nice light-purple rings. Coated seed	6.79 \$ 165 s/p
Red onion				
65-6682-010 Red Emperor F1	88		Here is the earliest red onion ever seen! Because of its genetic (intermediate days), it is very important to grow it as a transplant and transfer it in your garden as early as possible. You will then be able to harvest onions as soon as the end of July. Coated seed	6.79 \$ 165 s/p
65-6687-01B Monastrell F1	90		Early, dark red and of high caliber onion, Monastrell has great storage capacity. It can be cultivated from transplant or early direct seeding. To be harvested as soon as matured.	6.79 \$ 165 s/p
65-6693-01N Red Bull F1	115		This delicious onion maintains its dark red colour almost to its centre. Its strong skin ensures long shelf life. 7 to 8 cm in diameter.	5.69 \$ 165 s/p
65-6696-01B Red Carpet F1	116		Magnificent magenta interior rings make this an especially gorgeous red onion. Tight bulbs of 8 cm to 10 cm in diameter that store very well. Rich colour and flavour! Coated seed	6.79 \$ 165 s/p

PEAS



Spring



Little Marvel



Mr. Big



Little Snow Pea Purple



Alexandra



Altesse



Sweet Sensation



Snak Hero

Variety Code	Maturity (days)	Form.	Length (cm)	Number of peas (pod)	Variety Description	Price 1 Pkg
Pea - Shelling						
65-7809-280 Spring	52		7.5	6-7	Extra early, sweet-flavoured pea. Fast growing pods with good yields and excellent table quality. Productive, determinate, vigorous vines.	3.59 \$ 125 g
65-7809-0K0 Spring	52		7.5	6-7	Available in 1 kilo/packet.	*22.09 \$ 1 kilo
65-7825-28N Little Marvel	57		8	7	One of the sweetest, earliest peas! Each year, this easy-to-pick, consistent variety is tested and confirmed by our gardeners as a winning choice for fresh-from-the-garden consumption, canning and freezing.	3.59 \$ 125 g
65-7825-0KN Little Marvel	57		8	7	Available in 1 kilo/packet.	*22.09 \$ 1 kilo
65-7826-280 Alexandra	66		10	8-9	Here is a pea that grows on an upright plant that resists lodging making it easy to harvest. It has a bluish foliage that makes a beautiful contrast with the green pods. Excellent fresh or frozen.	7.89\$ 125 g
65-7826-0K0 Alexandra	66		10	8-9	Available in 1 kilo/packet.	*48.69 \$ 1 kilo
65-7856-28N Altesse	68		11	9-10	This pea will surprise you with its sweet crispy taste, erect plant habit and impressive yield. In addition, it has a very strong disease package.	7.89\$ 125 g
65-7856-0KN Altesse	68		11	9-10	Available in 1 kilo/packet.	*48.69 \$ 1 kilo
65-7852-280 Mr. Big	71		12.5	8-10	Mr. Big is an outstanding variety in the early class. It produces consistent, large, super tasting pea pods. Concentrated set. Easier to shell. Variety with high disease tolerance.	7.89\$ 125 g
65-7852-0K0 Mr. Big	71		12.5	8-10	Available in 1 kilo/packet.	*48.69 \$ 1 kilo
Pea - Snap						
65-7886-01N Little Snow Pea Purple	54		8-9	9-10	Green snow pea with a beautiful purple bicolor flowering. Little Snow Pea has an ornamental and culinary dual-use. Dwarf plant that will not surpass 50-60 cm in height so very good plant to use in containers.	4.59 \$ 75 s/p
65-7886-28N Little Snow Pea Purple	54		8-9	9-10	Available in 500 seeds/packet.	7.89\$ 125 g
65-7878-01N Sweet Sensation	65		8-9	8-10	Sweet Sensation is a "Snow" pea, meaning that it has a flat pod. Usually used in stir-fries, but can also be eaten fresh or frozen.	4.59 \$ 75 s/p
65-7878-28N Sweet Sensation	65		8-9	8-10	Available in 125 g/packet.	7.89\$ 125 g
65-7878-0KN Sweet Sensation	65		8-9	8-10	Available in 1 kilo/packet.	*48.69 \$ 1 kilo
65-7874-01N Snak Hero	67		10	8-9	Great early-season crop of slender, 10 cm long pods, that have the straight and elongated appearance of a green bean but the taste and texture of a snap pea. String less, super-sweet and delicious pods are perfect for healthy, garden-fresh snacking, stir-frying, or freezing. Self-supporting vines can be grown with or without support and are perfect for containers or hanging baskets. Frequent harvesting is recommended to bump up production for a long harvest window. 2020 All America Selection Winner.	4.59 \$ 75 s/p
65-7874-28N Snak Hero	67		10	8-9	Available in 125 g/packet.	7.89\$ 125 g
65-7874-0KN Snak Hero	67		10	8-9	Available in 1 kilo/packet.	*48.69 \$ 1 kilo



Pot-A-Peno F1

Chilly Chili F1
Patio CollectionApache F1
Patio CollectionCayennetta F1
Patio Collection

Early Jalapeno



Arapaho F1



Time Bomb F1



Primero Red F1

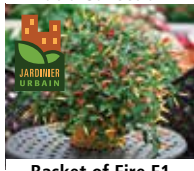

Velociraptor F1

Basket of Fire F1
Patio Collection

Gorria

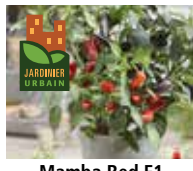
Mamba Red F1
Patio Collection

Hot pepper Mix



Bhut Jolokia

Variety Code	Maturity (days)	Form.	Type	Fruit size L x D (cm)	Variety Description	Price 1 Pkg
Hot Pepper						
65-7319-01N Pot-A-Peno F1	55		Jalapeno	8-10 x 2.5	Fun jalapeno pepper with a compact habit perfect for growing in containers and hanging baskets. Plant sets plentiful small, green jalapeno fruits that have a traditional spicy zip. Or leave the fruits on the vine a few extra weeks and they will ripen to red for a sweet, spicy flavour. A unique trait of Pot-a-peno is how the fruit hangs down beneath the plant making it very easy to harvest without damaging the appearance or productivity of the plant. 2021 All America Selection winner.	10.09 \$ 20 s/p
65-7310-01N Chilly Chili F1 Patio Collection	55		Chili	5 x 1	A family-friendly ornamental pepper with exceptional garden performance. Chilly Chili, as the name implies, is a non-pungent fruit. The "heat" was eliminated from the pepper by crossing. The fruit changes colour from yellow to orange, then red at maturity. Chilly Chili is extremely heat tolerant.	10.09 \$ 20 s/p
65-7308-01N Apache F1 Patio Collection	58		Chili	5-7 x 1	Mini hot red peppers (5-7 cm) with a delicious spicy taste.	7.89 \$ 20 s/p
65-7311-01N Cayennetta F1 Patio Collection	58		Chili	8-10 x 2	Chili type pepper that grows into a very well branched trailing plant, ideal for a hanging basket or a patio planter. What makes this variety unique is its very good tolerance to cold as well as its dense foliage cover that protects the fruits from the sun. Heavy yield of mildly hot peppers.	10.09 \$ 20 s/p
65-7322-01N Early Jalapeno	65		Jalapeno	9 x 4	Early. The mildest of the Jalapeno type. Thick walls. Ideal for salsa. Harvest spreads from summer to fall.	3.59 \$ 20 s/p
65-7332-010 Arapaho F1	68		Cayenne	15 x 3	Cheyenne is our earliest Cayenne. It gives a high yield of long and slender fruits on a compact plant. The fruits will turn from pale green to vibrant red at maturity. Medium pungency.	10.09 \$ 20 s/p
65-7376-010 Time Bomb F1	68		Cherry	3,5 x 4,5	Here is a cherry type hot pepper red in colour and pleasantly hot. Will turn red in mid-season.	6.79 \$ 20 s/p
65-7350-01N Primero Red F1	75		Habanero	8 x 3.5	The earliest ripening habanero on the market! They have about one third the heat of standard habaneros, letting gardeners appreciate their rich flavour.	7.89 \$ 20 s/p
65-7356-010 Velociraptor F1	80		Habanero	6 x 4	A habanero-style pepper, red, early, and high yielding that easily adapts to various growing conditions. It yields an abundance of very large, bright red-hot peppers that grow on a medium-sized plant. Excellent uniformity, beautiful colour, good smell, and the distinct taste of a classic habanero.	7.89 \$ 20 s/p
65-7307-01N Basket of Fire F1 Patio Collection	80		Chili	5-7 x 1	An avalanche of small, very hot and colorful fruits, from deep purple to cream to orange and to bright red when mature. Basket of Fire has a unique plant habit making it the perfect choice for hanging baskets and containers. The plants have a good tolerance to cooler weather. Harvested fruits will spice up your dishes until late in the fall. The fruits are also easy to dry.	10.09 \$ 20 s/p
65-7385-01N Gorria	80		Espelette	9-15 x 3	This Espelette type pepper is European pepper with a great reputation. Try it yourself, the plants can grow to be as much as 1 meter high. A well balanced hot pepper, with a score of 4 on the Scoville scale, which is between the Cayenne pepper and the sweet pepper.	7.89 \$ 10 s/p
65-7387-01N Mamba Red F1 Patio Collection	80		Chili	6 x 2,5	Mamba Red is an upright-growing pepper plant with mild spicy fruits. The glossy, fleshy fruits turn from a trendy black to a luscious red when ripening.	10.09 \$ 20 s/p
65-7300-010 Hot pepper Mix	65-80		Mix	Various	This blend contains the following hot peppers: Early Green Jalapeno, Small Red Narrow (Cayenne), Arapaho F1 (Cayenne), Hot Sunset F1 Yellow, Gorria Red.	3.59 \$ 20 s/p
65-7305-01N Bhut Jolokia	85		Bhut Jolokia	6-8 x 2,5-3	The 2007 Guinness World Records book certified Bhut Jolokia as the hottest pepper in the world at over 1 million Scoville units. Originally from India, it has rough dented fruits, 6-8 cm long by 2.5-3 cm wide and thin skin. Fiery hot flavour. The seeds and fruits should be handled with extreme caution.	10.09 \$ 20 s/p

SWEET PEPPER



Sweet Banana



Liberty Belle F1
Patio Collection



Classic F1



Socrates X3R F1



Greenbell F1



Giant Marconi F1



Tequila F1



California Wonder



Delirio F1



Early Sunsation X3R F1



Dragonfly F1



Abay F1

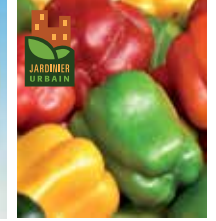

Rainbow Mix

Variety Code	Maturity (days) ^T	Form.	Colour	Fruit size L x D (cm)	Variety Description	Price 1 Pkg
Sweet Pepper - Banana						
65-7290-010 Sweet Banana	63	TR EXCL.	Yellow/red	18 x 4	A popular variety. This long, slender, sweet banana pepper is very productive in the garden.	3.59 \$ 20 s/p
Sweet Pepper - Bell						
65-7210-01N Liberty Belle F1 Patio Collection	55	UNT EXCL.	Yellow	10-12 x 4	Outstanding new patio pepper with a naturally dwarf habit that makes it perfect for use in patio containers. Large bright yellow fruits, well shaped and very sweet. A strong variety that withstands intense heat without fruit damage or diseases.	7.89 \$ 20 s/p
65-7236-01N Classic F1	65	UNT EXCL.	Green to bright red	9,5 x 9,5	A variety that will produce a greenhouse quality fruit in your garden. Very smooth and uniform fruits that turn from green to a beautiful red, with thick and juicy walls.	6.79 \$ 20 s/p
65-7234-01N Socrates X3R F1	65	UNT EXCL.	Green/red	11 x 11	Outstanding variety that will quickly give home gardeners the highest % of large red peppers. Colour transition is much quicker. A dependable variety with beautiful bright red fruits. High yielder.	11.09 \$ 20 s/p
65-7240-010 Greenbell F1	67	TR EXCL.	Green	11 x 9,5	Average in size, the productive plants give a harvest of large green fruits with thick walls. The fruits are of a better quality than those of Bell Boy.	6.79 \$ 20 s/p
65-7289-010 Giant Marconi F1	68	TR EXCL.	Bright green, red	18 x 8	Superb variety that can be used for grilling, roasting, frying, salads, salsa and hot dishes. The large, tapered green pepper will mature to red very rapidly, has high disease tolerance and is a high yielder.	10.09 \$ 20 s/p
65-7295-010 Tequila F1	68	TR EXCL.	Ivory to lilac	10 x 9,5	Very consistent. High production. Nice attractive lilac color.	6.79 \$ 10 s/p
65-7276-010 California Wonder	70	TR EXCL.	Medium to dark green	11 x 9,5	Popular variety often used by home gardeners. Thick wall. Tasty!	3.59 \$ 20 s/p
65-7259-010 Delirio F1	70	TR EXCL.	Orange	10 x 10	The large sized orange pepper varieties are not common, but you will be very happy with this Delirio variety. It produces large size fruits of great quality, similar to greenhouse peppers.	10.09 \$ 15 s/p
65-7279-01N Early Sunsation X3R F1	70	UNT EXCL.	Bright yellow	10 x 10	Early Sunsation is a unique, early variety that consistently produces 3 or 4 lobed, nicely shaped bell fruit. The green to yellow, medium-large. A high yielder, this sweet variety maintains firmness at the mature yellow stage.	10.09 \$ 20 s/p
65-7294-01N Dragonfly F1	72	UNT EXCL.	Purple	8,5 x 8,5	Beautiful purple peppers that have thick and sweet walls. This pepper transforms itself from a green fruit into a purple fruit. It is delicious at the green stage of maturity as it is when fully purple. Fruits grow high on the plant, keeping them from the soil. The 4-lobed fruits do not fade and if left on the vine, turn a beautiful, bright red colour. 2022 All America Selection Winner.	6.79 \$ 10 s/p
65-7280-01B Abay F1	73	EXCL.	Bright yellow	10 x 10	A yellow pepper that will produce large sized peppers with thick walls throughout the season.	10.09 \$ 20 s/p
65-7206-010 Rainbow Mix	55-75	TR EXCL.	Various	Various	Selected blend of high quality varieties with different maturities and colours. Harvest can be spread over a longer period of time, all summer.	4.59 \$ 15 s/p



Mattadores F1



Cornissimo F1



Snackabelle F1



Candy Cane F1

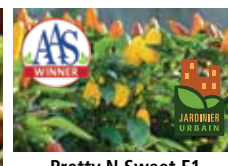

Pretty N Sweet F1
Patio Collection



Peppers from Heaven



Just Sweet F1



Hungarian Cheese
F1 Mix



Minisweet Mix F1



Mad Hatter F1



Dimitri F1



Takara F1

Variety Code	Maturity (days) ^T	Form.	Colour	Fruit size L x D (cm)	Variety Description	Price 1 Pkg
Sweet Pepper - Bull's Horn						
65-7270-010 Mattadores F1	70	TR EXCL.	Red	25 x 9	"Bull's Horn" type pepper, known as one of the longest sweet peppers in the world. Two or three lobes, relatively thin skin. Light sweet taste, to be used fresh or for processing.	10.09 \$ 20 s/p
65-7272-01N Cornissimo F1	75	UNT EXCL.	Green/ red	15-18 x 6	Extra-large Bull's Horn fruit that ripens from green to red, with outstanding thick walls, rich flavour and more sweetness than most large-fruited peppers. Great on the grill or stuffed and baked in the oven. To produce seedless fruit, grow in isolation from other non-seedless pepper varieties. If not isolated, it will produce larger, great-tasting fruits with just a few seeds. Best grown in-ground with the support of stakes or a cage.	10.09 \$ 20 s/p
Sweet Pepper - Mini						
65-7209-01N Snackabelle F1	55	UNT EXCL.	Green/ red	8 x 6	A tasty and original treat. Snackabelle offers a continuous yield of apple-shaped fruits, very sweet, ideal for eating raw or for stuffing.	7.89 \$ 20 s/p
65-7220-01N Candy Cane F1	60	UNT EXCL.	Green w/ stripes/ red w/ stripes	10 x 4	Fancy small pepper that ripens from green and white stripes to solid red. Its sweet flesh is perfect for eating at any stage of ripeness.	11.09 \$ 20 s/p
65-7213-01N Pretty N Sweet F1 Patio Collection	60	UNT EXCL.	Multi colored	2.5 x 4	At last! An ornamental pepper that can be eaten and tastes fantastic. Pretty N Sweet is just that: a sweet, multi-colored pepper on a compact 45 cm plant that is attractive to use in ornamental gardens and containers. Pretty N Sweet is early and prolific (you can harvest weekly in peak season) and has an amazing sweet taste with substantial pepper walls to enjoy. AAS 2015 winner.	7.89 \$ 20 s/p
65-7401-01N Peppers from Heaven Rouge F1 65-7402-01N Peppers from Heaven Jaune F1 65-7403-01N Peppers from Heaven Orange F1	75	UNT EXCL.	Red Yellow Orange	8 x 4	Peppers From Heaven are small, sweet peppers great for hanging baskets and 15-17 cm pots. Compact plants produce lots of fleshy fruit that turns green to glossy yellow, red or orange colour. Plant 3 plants in one basket for a fuller look. They are low maintenance and blooming season lasts from late spring to late summer. They are for culinary use, try them in each colour.	7.89 \$ 10 s/p
65-7296-01N Just Sweet F1	75	UNT EXCL.	Yellow	7 x 4	Here is a small unique 4-lobed snack pepper, similar to a Bell pepper, but smaller. The 7 cm fruits are deliciously sweet with nice thick walls and the plants are vigorous growers (up to 90 cm tall and 37 cm wide). You don't need stakes for this chili pepper as the plant has a very robust bushy growth habit. The Just Sweet snack pepper is sweet and has a bright and shiny colour that will please everyone. 2020 AAS Winner.	6.79 \$ 10 s/p
65-7264-010 Hungarian Cheese F1 Mix	75	TR EXCL.	Red/ orange/ yellow	4-6 x 2-3	Rather unusual, this mix of Hungarian peppers in three different colours will catch everyone's attention thanks to their bright colours and also for their unusual flat shape. Perfect to be used for stuffing or for eaten raw because of their excellent sweet taste.	10.09 \$ 20 s/p
65-7200-01N Minisweet Mix F1	75	UNT EXCL.	Yellow/ red/ golden	8-9 x 3	Now available as a mix of three shiny colours, these mini sweet peppers remain a favorite that pleases everyone either in a lunchbox or in raw vegetable platters. Can be grown in your garden or in a patio container on your balcony. The plants are loaded with small, smooth, sweet fruits with very few seeds.	10.09 \$ 15 s/p
65-7214-01N Mad Hatter F1	85	UNT EXCL.	Green/ red	5-8 x 5-6	Intriguing small flattened-disc shape pepper with lobes or wings. Mad Hatter is crunchy, crisp and mild. Ideal for eating at mature green or ripe red stage. A large indeterminate plant that will benefit from a support or a trellis.	11.09 \$ 20 s/p
Sweet Pepper - Shepard						
65-7265-010 Dimitri F1	68	TR EXCL.	Red	20 x 5	Italian type pepper with smooth fruits, in a conical shape and with a pointed tip. The ideal pepper for roasting but can also be pickled.	10.09 \$ 20 s/p
Sweet Pepper - Shishito						
65-7286-010 Takara F1	63	TR EXCL.	Light green, red	9 x 3	Takara is a typical Shishito pepper with a small fruit and a mild but rich flavour. Takara may exhibit 5 to 10% fruits that are spicy or pungent under stressing climatic conditions like hot and dry temperature. This phenomenon makes it fun to grow in your garden.	10.09 \$ 20 s/p

PUMPKIN



Atlantic Giant



Big Doris F1



New Moon F1 White



Moon Stacker F1



Bad Jelly F1



Hot Chocolate F1



Orange Sunrise F1



Porcelain Doll F1



Blue Doll F1



Carrie F1



Sunlight F1



Spicy Mocha F1

Variety Code	Maturity (days)	Form.	Fruit size H x D (cm)	Fruit Weight (kg)	Colour	Variety Description	Price 1 Pkg
Pumpkin Extra large							
65-4089-010 Atlantic Giant	120+		100 x 100+	50+	Orangey	This "jolly orange giant" was created by Mr. Howard Dill of Windsor in Nova Scotia. Each year, it is quite in demand by both the curious and competitive growers. 'Atlantic Giant' has shattered all previous records.	6.79 \$ 10 s/p
Pumpkin large							
65-4037-010 Big Doris F1	100		45 x 44	12-14	Dark orange	A large size and dark orange variety with a strong handle. It's yield is impressive with an earliness that will leave you some time to decorate for the big night.	6.79 \$ 20 s/p
Pumpkin Medium							
65-4076-010 New Moon F1 White	90		35 x 35	13-16	White	Here is a big pumpkin that is as white as a ghost. Even its flesh is white! Grown under ideal conditions its diameter can reach up to 40 cm and its weight up to 20 kg.	6.79 \$ 10 s/p
65-4071-010 Moon Stacker F1	95		17 x 30	13-16	White	A charming white skinned pumpkin who has a super-thick, bright yellow-orange flesh. It's very oblate shape with ribbing is perfect for stacking as its name implies. Pairs beautifully with blue, pink and red stacking varieties. This pumpkin has high eating quality flesh and a long storage life.	7.89 \$ 20 s/p
65-4048-010 Bad Jelly F1	95		30 x 30	5,5-7	Banana yellow	Bad Jelly is an absolutely unique banana yellow coloured warty pumpkin. Its average weight is 5.5 kg to 7 kg on a medium vine. Originality guaranteed.	6.79 \$ 20 s/p
65-4047-010 Hot Chocolate F1	95		20 x 20	2,5-3.5	Chocolate brown	An attractive little chocolate-brown pumpkin with a strong handle. Hot Chocolate offers a high yield of 2 kg to 3.5 kg fruits on a medium type vine. Another specialty pumpkin to "wow" the neighbourhood.	6.79 \$ 20 s/p
65-4018-010 Orange Sunrise F1	100		25 x 25	7-9	Orange	A beautiful early maturing pumpkin with a very attractive dark orange colour. It's beautiful round shape as well as its ribbing allows it to have a very easy format to handle. Strong dark green handle. The ideal variety to grow for a good Halloween production. Intermediate resistance to powdery mildew. Replaces the Orange Rave variety.	6.79 \$ 20 s/p
65-4078-010 Porcelain Doll F1	100		20 x 30	8-10	Pink	Porcelain Doll is an exotic pink pumpkin, very eye-catching it can be decorated for any celebration. Its shape is almost square and it has deep ribbing. Its flesh is orange and sweet, perfect for pies, soups and other culinary delights. Good tolerance to Powdery Mildew.	6.79 \$ 20 s/p
65-4079-010 Blue Doll F1	100		20 x 30	8-10	Blue	Blue Doll is the blue version of the Porcelain Doll. An exotic pumpkin with an almost square shape, very ribbed, with sweet orange flesh that can be used for cooking. Good tolerance to Powdery Mildew.	6.79 \$ 20 s/p
65-4038-01N Carrie F1	100		27 x 27	7-9	Dark orange	Nice, round Halloween pumpkin, smooth and uniform, in a dark orange colour. You will enjoy carving Carrie, pick up its seeds or even cook with it.	6.79 \$ 20 s/p
65-4082-010 Sunlight F1	100		15 x 20	2	Bright yellow	A small bright yellow pumpkin that will add color to the usual orange shades of Halloween. Ribbed fruit that comes with a strong dark green handle. Compact vine. Tolerance to Powdery Mildew.	6.79 \$ 20 s/p
65-4067-010 Spicy Mocha F1	105		20 x 20	7-10	Brown	Beautiful coffee-coloured round pumpkin that adds a touch of originality to your garden. The medium-size vine shows a good disease tolerance.	7.89 \$ 20 s/p



Scarface F1



Popcorn F1



Grizzly Bear F1



Phantomita F1



Jack Sprat F1



Jade Knight F1



Blaze F1



Fireball F1



Small Sugar



Black Kat F1



Casperita F1 Blanche



Orangita F1



Galaxy of Stars F1



Ga Ga Ga F1

Variety Code	Maturity (days)	Form.	Fruit size H x D (cm)	Fruit Weight (kg)	Colour	Variety Description	Price 1 Pkg
Pumkin medium							
65-4069-010 Scarface F1	105		25 x 20	9-10	Orange	Medium size, dark orange pumpkin, with beautiful large greenish warts for a terrifying look. Full vine. Solid handle.	7.89 \$ 20 s/p
65-4045-010 Popcorn F1	110		27 x 22	8	White	Creamy white, heavily warted pumpkin that will surely draw attention in your fall display. Strong, dark green vines set reliable yields of 8 kg fruits with well-attached, long, dark green stems. The pale fruits will become of a buttery colour with time. Handle fruit with care to minimize damage to the warts.	6.79 \$ 20 s/p
Pumkin small							
65-4084-010 Grizzly Bear F1	85		12-15 x 12-15	2,5-3,5	Light brown	A strange enough light brown, ribbed, wart covered and small pumpkin with a large vine.	6.79 \$ 20 s/p
65-4053-010 Phantomita F1	90		8 x 16	0,5-0,7	Tricolour	A good production of beautiful, flat, highly ribbed fruit with unique colour and stripe pattern. The flesh and sugar content are like an acorn squash. A variety to try this year without a doubt.	7.89 \$ 20 s/p
65-4021-010 Jack Sprat F1	90		13 x 11	1.4	Dark orange	Very nice small pumpkin, of a nice dark color. The fruits are perfectly uniform, in size as well as in shape and have a solid handle. Perfect for the gardens!	6.79 \$ 20 s/p
65-4063-010 Jade Knight F1	90		14 x 19	3-4,5	Grey-dark green	Grow a square-shaped, flattened, moderately ribbed pumpkin with a unique dark graygreen colour. Trailing vines are excellent yielders and have intermediate resistance to powdery mildew and zucchini yellow mosaic virus. The pumpkin you need to vary your fall decorations. Thick bright yellow flesh, that has a pleasant taste.	7.89 \$ 20 s/p
65-4086-010 Blaze F1	95		9 x 18	1.4	Yellow striated of orange	Presenting a lovely, small-sized and of originally shape pumpkin, bearing special colours. Its dark green handle is firmly attached. This vigorous plant tolerates powdery mildew.	6.79 \$ 20 s/p
65-4060-010 Fireball F1	110		16 x 16	4	Orange striped yellow	An explosive addition to your pumpkin varieties! Yellow coloured fruits with orange stripes that form a unique pattern. The plants give excellent yields of pumpkins that hold up very well after harvest. Everyone will love this very attractive variety.	7.89 \$ 20 s/p
65-4060-010 Small Sugar	115		15 x 18	2,5-3	Orangey	Small orange pumpkin with a sweet flesh, very popular to bake pies or in preserves.	3.59 \$ 50 s/p
Pumpkin Mini							
65-4099-010 Black Kat F1	95		6 x 12	0,25 - 0,50	Very dark green	Black Kat is a great single-portion hybrid pumpkin with a semi-bushy habit that produces abundantly. It combines a classic pumpkin shape with a unique appearance and can be grown for ornamental as well as culinary purposes. Black Kat will be a sensation in fall arrangements.	6.79 \$ 20 s/p
65-4092-010 Casperita F1	95		8 x 11	0.25-0.5	White	Casperita is a larger mini white pumpkin in a classic shape with deep ribs and a strong, green handle. This attractive pumpkin also has sweet, white flesh that eats similar to Acorn squash. Casperita produces good yields of 0,25-0,5 kg fruit.	6.79 \$ 20 s/p
65-4087-010 Orangita F1	95		8 x 12	0.5-0.7	Bright orange	Charming small decorative pumpkin with a sweet taste, reminding of the acorn squash. The fruits are very ribbed and very even.	6.79 \$ 20 s/p
Ornamental gourd							
65-4689-010 Galaxy of Stars F1	95		Various	Various	Mixture	An exciting and attractive gourd mixture, Galaxy of Stars brings a little kick to your fall decorations. The mix produces unique star-shaped fruits of changing striped patterns in various colours: yellow, cream, orange, green, and white.	6.79 \$ 20 s/p
65-4682-01N Ga Ga Ga F1	100		25 x 8	n/d	Golden yellow	This crooked ornamental squash has two types of using. The young, light-yellow fruits have a buttery flavour, a firm texture and are very nice for cooking. The fully ripen, golden yellow, blistered fruits are very attractive for fall decoration. Vigorous, bushy variety.	6.79 \$ 20 s/p

SQUASH



Sunny Delight F1 (scallop)



Orangetti F1



Primavera F1



Improved Vegetable Spaghetti



Stripetti F1



One Ball F1



Golden Glory F1



Easy Pick Gold II F1 Patio Col

Variety Code	Maturity (days)	Form.	Colour	Fruit Length (cm)	Variety Description	Price 1 Pkg
Summer squash - Scallop						
65-4532-010 Sunny Delight F1	42		Dark yellow	6-8	Here is the yellow version of the zucchini Eight Ball. Small perfectly round bright yellow squash on an erect open plant. An early harvest that will bring colour to your grilled vegetables dishes.	5.69 \$ 15 s/p
Summer squash - Spaghetti						
65-4525-010 Orangetti F1	65		Orange	15-18	A dark orange coloured spaghetti squash, slightly sweet, low in calories and rich in provitamin A. Fruits average 900 g. when cooked for 11 minutes the orange flesh breaks apart into spaghetti noodles.	5.69 \$ 15 s/p
65-4517-010 Primavera F1	68		Pale yellow	20-22	Hybrid variety of intermediate habit, with a more compact plant than most other spaghetti varieties. One to two (1 to 2) kg fruit.	5.69 \$ 15 s/p
65-4515-01B Improved Vegetable Spaghetti	70		Pale yellow	20-25	A very popular variety with a nice yellow flesh, it has the appearance of spaghetti noodles. Running vine. Keeps a long time in a cool area.	5.69 \$ 15 s/p
65-4520-01N Stripetti F1	85		Tan stripe green	30	A spaghetti squash with a unique tan colour with green striped skin. The fruit has the same "noodle" interior, with a sweet taste. Vigorous vine.	5.69 \$ 15 s/p
Summer squash - Zucchini Yellow						
65-4541-010 One Ball F1	45		Bright yellow	6-8 diameter	Here is the yellow version of the zucchini Eight Ball. Small perfectly round bright yellow squash on an erect open plant. An early harvest that will bring colour to your grilled vegetables dishes.	5.69 \$ 15 s/p
65-4554-01N Golden Glory F1	45		Dark yellow	18-20	If you have difficulty growing yellow zucchinis because of diseases affecting the plants, Golden Glory might be the answer to your problems. This high quality, bright yellow zucchini has excellent tolerance to many Mosaic viruses and Powdery Mildew.	5.69 \$ 15 s/p
65-4545-01N Easy Pick Gold II F1 Patio Col.	45		Bright yellow	18-20	Variety adapted to either containers or garden. It is very easy to harvest thanks to its open plant with no spines. Reaches a height and width of 90-130 cm.	5.69 \$ 15 s/p



Ishtar F1



Eight Ball F1



Easy Pick F1 Green Patio Collection



Green Machine F1



Home Garden



Zou Sing F1



Buttercup Burgess



Sunshine F1

Variety Code	Maturity (days) ^S	Form.	Colour	Fruit Length (cm)	Variety Description	Price 1 Pkg
Summer squash - Zucchini Libanese						
65-4580-010 Ishtar F1	45		Pale green	12-14	This Lebanese type zucchini produces short and smooth, light green and white mottles fruits. The yield is high and harvest extends the growing season.	5.69 \$ 15 s/p
Summer squash - Zucchini Green						
65-4542-010 Eight Ball F1	45		Medium dark green	6-8 diameter	This unique early zucchini has a perfectly round shape and nice medium green color. This variety produces its fruits on a compact and open habit making it easy to pick.	5.69 \$ 15 s/p
65-4559-01N Easy Pick F1 Green Patio Collection	45		Dark green	18-20 x 4	A variety adapted to containers or the garden. Very easy to harvest thanks to its open plant with no spines. Reaches a height and width of 90-130 cm.	5.69 \$ 15 s/p
65-4571-01B Green Machine F1	48		Medium to dark green	19-22	It produces higher yields of nice medium to dark green fruits. Its compact plant will use less space in your garden and the open plant habit makes it easier to harvest. It also shows a good tolerance to many diseases, so a good durability throughout the season.	5.69 \$ 15 s/p
Summer Squash - Mix						
65-4500-010 Home Garden Blend	--		Mix	Various	A special blend selected for your garden. Grow five of the most popular varieties from the same packet. Squash Vegetable Spaghetti, squash Acorn Heart of gold, squash scallop Sunny Delight, squash buttercup Sunshine and green zucchini Quirinal.	5.69 \$ 15 s/p
Summer Squash - Luffa						
65-4538-01N Zou Sing F1	55		Dark green	50-60	Your favourite scrubber actually comes from a vegetable, a long ridged type of squash. The early maturing dark green fruits are 50-60 cm long. This variety is not sensitive to day length. It is adapted to long summer days. The very long vine needs to grow on a trellis until maturity. Remove all the flowers from the vine below 1.20 m if any. Fruits are ready to pick when the green skin has turned dark yellow or brown and starts to separate from the fiber. Start from transplants.	5.69 \$ 15 s/p
Winter squash - Buttercup						
				Plant Habit		
65-4605-010 Buttercup Burgess	100		Dark green	Vine	A nice, Buttercup type, winter squash, produces spotted dark green and silvery lined fruits. It has a rich taste reminiscent of sweet potatoes. It keeps very well.	3.59 \$ 15 s/p
65-4606-010 Sunshine F1	100		Dark orange	Compact	The tender flesh of this buttercup squash is bright orange, sweet and tender, ideal for cooking, mashing and pies. Dark colored, the fruits are slightly flat round and 1.4 to 2.3 kg in weight. This compact vine produces 3 to 4 fruits per plant.	5.69 \$ 15 s/p

SQUASH



Quantum F1



Honeynut (Mini)



Havana F1



Butterkin F1



Uchiki Kuri



Heavenly Hubbard F1



Sweet Mama F1



Mashed Potatoes F1



Goldilocks F1



Table Queen



Bush Delicata

Variety Code	Maturity (days)	Form.	Colour	Plant habit	Variety Description	Price 1 Pkg
Winter squash - Butternut						
65-4615-010 Quantum F1	85		Tan	Vine	Quantum has a very high yield and high fruit uniformity. Its vine is also much healthier and will stay green for longer in the season, so you can harvest the fruits later in the season in order to store them. Fruit weight :1,1-2 kg.	5.69 \$ 15 s/p
65-4621-01N Honeynut (Mini)	85		Dark tan	Vine	An appealing mini butternut squash, an outcome of a research program from Cornell University. Honeynut is an open pollinated plant with a strong tolerance to powdery mildew. It produces an abundant yield of uniform mini fruits with a very high sugar content when fully ripe when fully coloured. Stores well.	5.69 \$ 15 s/p
65-4618-01B Havana F1	85		Tan	Semi-vine	Early ripening butternut squash that gives big blocky, fragrant and fleshy fruits. The flesh is deep orange and tasty. Vigorous plants that are well adapted to North America's growing conditions. Replaces the Tiana variety.	6.79 \$ 15 s/p
65-4608-010 Butterkin F1	100		Tan	Vine	Get some attention to your garden with this new and unusual cross between a Butternut and a pumpkin. This results in vibrant orange fleshed fruits, with a creamy, smooth and sweet flesh. Ideal for roasting, baking, soups or pies.	6.79 \$ 15 s/p
Winter squash - Hubbard						
65-4632-01N Uchiki Kuri	95		Red orange	Vine	Uchiki Kuri is a Japanese type Hubbard with a dark red-orange skin, and delicious creamcoloured flesh. Its flesh is flavourful, firm but never stringy, which makes it very popular in Japanese and Thai dishes. Uchiki Kuri plants are robust and productive even in our climatic conditions, providing 3 or more fruits per plant. The fruits average 1.5 kg each. Early variety.	7.89 \$ 15 s/p
65-4625-010 Heavenly Hubbard F1	100		Grey green	Vine	The first hybrid Hubbard squash on the market. Greyish green fruit full of warts. Its yellow flesh has a fine texture and a sweet taste. Ideal to make original fries.	6.79 \$ 15 s/p
Winter squash - Kabocha						
65-4635-01N Sweet Mama F1	85		Dark green	Bush	This squash has a texture and the shape similar to a cupless Buttercup. Keeps better and has a better taste than the Buttercup.	7.89 \$ 15 s/p
Winter squash - Acorn						
65-4649-010 Mashed Potatoes F1	85		White	Compact	Stark white acorn that will hold its pure colour into late fall. The flesh is nearly white and resembles mashed potatoes when baked and fluffed. A delicious change in your dishes. Most of the fruits are found on the crown set.	5.69 \$ 15 s/p
65-4650-01N Goldilocks F1	85		Orange	Bush	Bright orange acorn squash with a uniform shape and colour used for both food and decoration. The plants are vigorous, the yield is good and the nutty flavour is delicious. 2021 All America Selection Winner.	6.79 \$ 15 s/p
65-4657-01B Table Queen	90		Dark green	Bush	Ribbed fruit with smooth thin but solid skin. Orange flesh that is very tasty when cooked. Ideal to accompany meat or to use for stuffing.	5.69 \$ 15 s/p
Winter squash - Specialty						
65-4660-010 Bush Delicata	80		Cream / green stripes	Bush	Eye-catching fruits with green striping over a creamy white background. Noticed for its smooth internal texture and sweet, nutty flavour. An early variety on a compact plant, a spacer saver for the garden.	4.59 \$ 15 s/p



Early Scarlet Globe



Poker



Rover F1

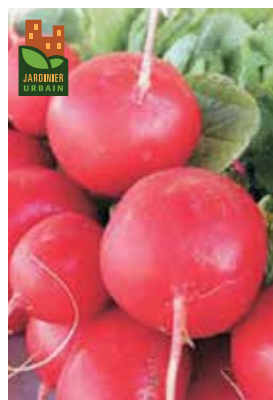

Escala F1



Purpella F1



Icicle White



Easter Egg II



French Breakfast



Round Black Spanish



Rido F1 Red

Variety Code	Maturity (days)	Form.	Colour	Variety Description	Price 1 Pkg
Radish					
65-8005-01B Early Scarlet Globe	21		Bright red	Early variety with excellent taste.	3.59 \$ 300 s/p
65-8010-010 Poker	21		Bright red	This early variety is tolerant to disease and drought. A great addition to a child's first garden; this cherry red veggie will be ready to pick in just 3 weeks.	5.69 \$ 300 s/p
65-8019-010 Rover F1	22		Dark red	Rover offers constant performance and yield all season long. It can be grown in cooler temperatures in the beginning or at the end of the season as well as in the middle of summer, without losing quality. Nice vibrant red globes.	3.59 \$ 300 s/p
65-8023-01N Escala F1	22		Bright red	Round and brilliant red bulbs that have excellent uniformity, good internal quality and are cracking tolerant. Excellent taste. Best for summer and fall crops.	4.59 \$ 300 s/p
65-8062-01N Purpella F1	27		Purple	Surprising dark purple radish with good uniformity and high yields. Sizes up very quick and shows good field holding ability. Its interior stays shiny white and crispy. Can be grown in greenhouse as well as outdoors. A radish to be added in your vegetable garden.	6.79 \$ 150 s/p
65-8070-01N Icicle White	27		White	Mild taste! Unique!	3.59 \$ 300 s/p
65-8060-010 Easter Egg II	28		White-Pink-Purple-Red	Add color to your salads and raw veggies with these white, pink, violet and red colored roots - Uniform shape and maturity with a great taste.	3.59 \$ 300 s/p
65-8055-010 French Breakfast	28		Red-White tip	An early radish with an elongated shape and white tip. A delicate taste that will please connoisseurs.	3.59 \$ 300 s/p
65-8075-01N Round Black Spanish	55		Black	Internal flesh is cream-coloured! Strong taste. Unusual!	3.59 \$ 300 s/p
Radis specialty					
65-8077-01N Rido Red F1	60		Pale green	The watermelon radish has a ball-shaped root that can reach 10 cm in diameter. Its green external color fades to white. When cutting a watermelon radish, you will find a nice red flesh just like a watermelon. The taste is delicate with a sweet and mild flavor. Excellent in salads, as a garnish or when cooking Asian dishes. Note: This is a fall crop , so sow after June 21st.	6.79 \$ 150 s/p

TOMATO - ROUND



Siberia



Polbig F1



Patio F1

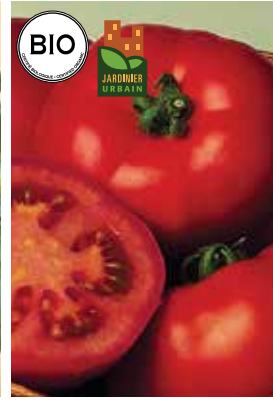

Caiman F1



Tasti-Lee F1



Goldmine F1



Pink Cupcake F1



Homeslice F1 Collection Patio



DarkStar F1



Pink Girl F1

Variety Code	Maturity (days) ^T	Form.	Plant size	Colour	Fruit weight (g)	Variety Description	Price 1 Pkg
Tomato - Round							
65-9011-01N Siberia	48	UNT EXCL.	Very small Det.	Red	125	Vigorous tomato that tolerates diversity of temperatures. Plants are 45 to 60 cm in height and will produce 40 to 60 fruits. Green shoulder. Very well liked by gardeners.	3.59 \$ 20 s/p
65-9015-01N Polbig F1	55	UNT EXCL.	Small Det.	Red	170-225	Very round, firm, fleshy fruits. Excellent yield. Well adapted to cold regions.	11.09 \$ 20 s/p
65-9002-010 Patio F1	60	TR EXCL.	Small Det.	Red	115	With a compact and erect plant. Ideal for containers, pots, and small garden areas. Green shoulder.	5.69 \$ 20 s/p
65-9086-01B Caiman F1	64	EXCL.	Large Indet.	Red	220-240	An early Beefsteak tomato, on a vigorous and open plant, very easy to grow. Produces round fruits, dark red in color with a very appreciated great taste.	7.89 \$ 15 s/p
65-9026-01N Tasti-Lee F1	64	UNT EXCL.	Medium Det.	Red	180-200	ts fruits have a high lycopene (antioxidant) content for those who are concerned with their health. Tasti-Lee grows on a determinate plant that consistently produces flavourful fruits, average weight of 180 g, all through the season. The fruits have a rich red colour inside and out. The fruits remain firm even when fully mature.	10.09 \$ 15 s/p
65-9209-010 Goldmine F1	65	TR EXCL.	Large Indet.	Yellow	225-240	Popular variety. Very productive plant. Bright yellow colour. Distinct taste, less acid than the red fruit varieties.	5.69 \$ 20 s/p
65-8882-01N Pink Cupcake F1	65	UNT EXCL.	Medium Det.	Pink	200-250	Early pink tomato, without green shoulders, very firm and with a great taste. A better choice than Pink Girl for its firmness.	6.79 \$ 20 s/p
65-9000-01N Homeslice F1 Collection Patio	65	UNT EXCL.	Small Det.	Red	140-200	A vigorous, compact variety that produces tomatoes in abundance. Plants are perfect for growing in patio containers or small gardens and the fruit has a delicious old-fashioned tomato flavour.	6.79 \$ 20 s/p
65-9003-01N DarkStar F1	65	UNT EXCL.	Large Indet.	Purple	225-280	A happy marriage between heirloom tomato flavour and modern hybrid tomato performance. Early maturing, rich, purple beefsteak fruits, with a higher yield potential and fewer blemishes than most heirlooms. The large plant offers high disease resistance to late blight, for a longer harvesting season. Best grown in ground or with the support of trellis or cages.	6.79 \$ 20 s/p
65-8880-01N Pink Girl F1	65	UNT EXCL.	Large Indet.	Pink	225	Large calibre, smooth and uniform fruit of good quality. High tolerance to splitting and very productive. Fruits may have green collar.	6.79 \$ 20 s/p



Celebrity Plus F1



Mountain Merit F1



Chef's Choice F1 Yellow



Chef's Choice F1 Orange



Heirloom Marriage Genuwine F1



Big Beef Plus F1



Pink Delicious F1



Mega Fantastique F1

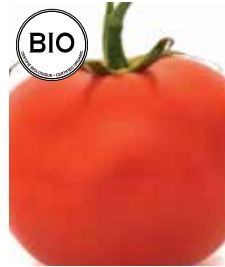

Marmande



Heirloom Marriage Cherokee Carbon F1

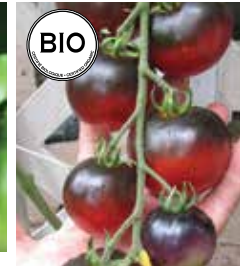

Indigo Apple

Variety Code	Maturity (days)	Form.	Plant size	Colour	Fruit weight (g)	Variety Description	Price 1 Pkg
Tomato - Round							
65-9029-01N Celebrity Plus F1	68		Medium Det.	Red	200	Improvement of the famous variety Celebrity. Same good yield, same delicious taste, but with more disease tolerance.	7.89 \$ 20 s/p
65-9046-01N Mountain Merit F1	69		Small Det.	Red	225-280	Mountain Merit is considered as a superior tomato by vegetable growers. With a 4-5 week harvest window, the dark red fruits grow on a compact, determinate plant and offer good resistance to multiple diseases common to homegrown tomatoes such as late blight. High adaptability. An all-around flavorful fruit, perfect for sandwiches or as side-dish.	6.79 \$ 15 s/p
65-8898-01N Chef's Choice F1 Yellow	70		Large Indet.	Yellow	300	Here is a savoury addition to the Chef's Choice tomato selection. Yellow Beefsteak type on a very productive indeterminate plant. At least 30 fruits of 300 g per plant, of large meaty delicacy. A sweet citrus-like flavour with just the right amount of acidity.	6.79 \$ 20 s/p
65-8899-01N Chef's Choice F1 Orange	70		Large Indet.	Orange	330	Experience the excellent flavor of this orange tomato in only 70 days from transplant! Chef's Choice Orange has a wonderfully bright, almost neon, internal color and superior flesh taste and texture for an early maturing orange tomato. The leaves cover fruit well to protect from sunburn. AAS 2015 winner.	6.79 \$ 20 s/p
65-9100-01N Heirloom Marriage Genuwine F1	70		Large Indet.	Red	300-330	This variety replaces the Brandywine and reaches its maturity up to 2 weeks earlier! A crossing between two heirlooms to create an early tomato of better quality and high yields but keeping its same good old taste.	6.79 \$ 20 s/p
65-9093-01N Big Beef Plus F1	73		Large Indet.	Red	280-400	Improvement of the popular variety. Sweeter taste (more Brix), redder interior and exterior colour with a greater tolerance to disease.	6.79 \$ 20 s/p
65-8881-01N Pink Delicious F1	75		Large Indet.	Pink	300	Tomate géante de style ancien, aussi rose que délicieuse! Plus hâtive et meilleur rendement que la plupart des tomates roses. Meilleure germination et plus grande tolérance aux maladies aussi, ce qui la rend plus facile à cultiver. Gros fruits qui craquent moins en plus d'avoir une saveur plus sucrée que les tomates rose habituelles.	6.79 \$ 20 s/p
65-9081-01N Mega Fantastique F1	75		Large Indet.	Red	175-185	Replacing famous Fantastic tomato, here is Mega Fantastic. Same vigorous plant, same tomato size and colour, same favorite taste, appreciated by gardeners for years.	5.69 \$ 20 s/p
65-9088-01B Marmande	75		Medium Semi-det.	Red	150-200	A superb quality. A variety producing flattened fruits of good calibre. A delight to the home gardener.	6.79 \$ 20 s/p
65-9075-01N Heirloom Marriage Cherokee Carbon F1	75		Large Indet.	Purple	280-350	This tomato is a robust beefsteak type, purple in colour, with a rich flavor that comes from a cross of Cherokee Purple x Carbon.	7.89 \$ 20 s/p
65-9077-01B Indigo Apple	72		Large Indet.	Purple / red	55-110	A larger Indigo tomato with exceptionally high anthocyanin content. Sweet, rich flavored fruits resist cracking and sunscald, lasting long into cool autumn weather when others have quit. Firm, meaty fruits turns red when ripe and show disease tolerance.	7.89 \$ 20 s/p

TOMATO - ROUND

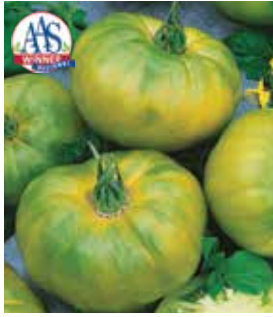

Chef's Choice F1 Green



Buffalosun F1



Striped German (Heirloom)



Marriage Big Brandy F1 (Heirloom)



Long Keeper



Stuffer Striped (Heirloom)



Beefsteak



Chef's Choice F1 Pink



Chef's Choice F1 Mix



Oxheart

Variety Code	Maturity (days) ¹	Form.	Plant size	Colour	Fruit weight (g)	Variety Description	Price 1 Pkg
Tomato - Round							
65-8897-01N Chef's Choice F1 Green	75		Large Indet.	Green	250-280	This addition to the Chef's Choice series produces unique green coloured fruits with subtle yellow stripes and a wonderful citrus-like flavour with a perfect tomato texture. Plant is disease free throughout the season. Perfect for your foodie customers! Winner AAS Regional.	6.79 \$ 20 s/p
65-9096-01N Buffalosun F1	75		Large Indet.	Orange-red	300-350	All of a heritage tomato with better texture, higher yield and less cracking. Buffalosun will give you beautiful orange-red fruit on the outside, nicely marbled on the inside, until the end of the season. Its indeterminate plant produces fruits with a sweet taste, a tender flesh without a pasty texture. For a good performance in the garden, it is recommended to stake Buffalosun. 2020 AAS Winner.	6.79 \$ 10 s/p
65-9097-01N Striped German (Heirloom)	78		Large Indet.	Yellow	175-185	A unique heirloom selection producing bicoloured red and yellow fruits. The flat, medium to large, variably ribbed shoulder is about equally shaded, striped yellow and red. Bicolour interior, appealing and flavourful nice texture.	6.79 \$ 20 s/p
65-9099-01N Marriage Big Brandy F1 (Heirloom)	78		Large Indet.	Pink	350-425	This new tomato, created from a cross between two heirlooms, is a new pink Beefsteak with better yield and earlier maturing and a great flavor. Best used in gardens.	6.79 \$ 20 s/p
65-9091-01N Long Keeper	78		Large Indet.	Red	175-185	The best storage variety. Eat great tomatoes all winter long. Large, orange-red, juicy and delicious fruits. Pick when partially ripe, before the first frost. Wrap each tomato individually in newspaper and keep in a cool place. They will keep 6 to 12 weeks.	4.59 \$ 80 s/p
65-9098-01N Stuffer Striped (Heirloom)	78		Med/large Indet.	Red	170	A stuffing tomato with thick walls, the fruit weighs about 170 g, striped in deep red and orange. Stuff it with vegetables, rice, fish or cheese and savour it raw or oven baked.	6.79 \$ 20 s/p
65-9095-01B Beefsteak	80		Medium Det.	Red	200-700	A favourite for those who love meaty, thick and tasty large tomatoes for sandwiches.	5.69 \$ 20 s/p
65-8896-01N Chef's Choice F1 Pink	85		Large Indet.	Pink	335-400	To complement the Chef's Choice selection, here is a large pink beefsteak tomatoes. The perfect acid to sugar balance in this tomato makes it a must for any home chef. Consider canning these beautiful tomatoes. The potato leaf-like plant has good disease resistance.	6.79 \$ 20 s/p
65-8900-01N Chef's Choice F1 Mix	70-85		Large Indet.	Mix	Variable	Get the complete Chef's Choice tomato collection in a single envelope. Each indeterminate plant will provide abundant harvest of yellow, green, orange or pink fruits for an all-tomato summer.	6.79 \$ 20 s/p
65-8895-01N Oxheart	100		Very large Indet.	Rose	300-350	Popular variety. Very large, fleshy, heart-shaped fruit. Green shoulder. Delicious.	3.59 \$ 80 s/p

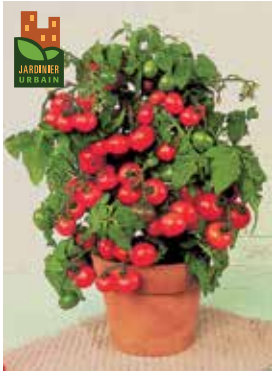

Tiny Tim

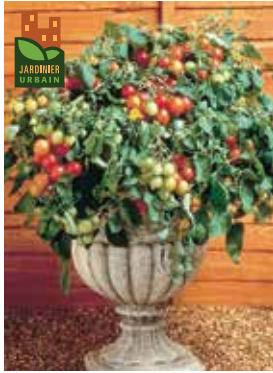

Tumbler F1



Candyland F1



Chocolate Sprinkles F1



Sugar Gloss F1



Sweet'N'Neat F1 Scarlet



Sweet'N'Neat F1 Yellow



Moncherry F1



Pepe F1



Jasper F1

Variety Code	Maturity (days)	Form.	Plant size	Colour	Fruit weight (g)	Variety Description	Price 1 Pkg
Tomato - Cherry							
65-9234-01N Tiny Tim	45		Small Det.	Red	Less than 25	Early, small and compact red tomato. Recommended for growing in pots.	3.59 \$ 20 s/p
65-9236-01N Tumbler F1	45		Medium Det.	Red	25-30	This variety feature fruits of about 3 cm in diameter. Tumbler has a graceful, cascading habit and produces up to 2.7 kg of cherry-type tomatoes.	6.79 \$ 15 s/p
65-9245-01N Candyland F1	55		Large Indet.	Red	7-8	A very nice small cherry tomato that can be compared to the Bonbon variety. Candyland's fruits are bright red in colour with a sweet taste. It will produce a lot of fruits that are easy to harvest because its trusses grow outside of the plant making them easy to reach.	6.79 \$ 20 s/p
65-9291-01N Chocolate Sprinkles F1	55		Large Indet.	Red with green sprinkles	20	Here is the first cherry tomato with a chocolaty sprinkled colour that resists diseases. It also produces more fruits with better flavor than other open pollinated tomatoes of the same colour. Best grown inground.	7.89 \$ 10 s/p
65-9253-01N Sugar Gloss F1	55		Medium Indet.	Red	20-25	Sugar Gloss produces the most garnished tomato trusses you have ever seen! Each truss can contain up to 60 glossy red fruits, that weight around 20-25 g each. They also have a good flavor with a 12% Brix rating.	7.89 \$ 20 s/p
65-9246-01N Sweet'N'Neat F1 Scarlet	55		Small Det.	Scarlet red	25	Here is an all-new ultra compact cherry tomato, especially suited for patio containers and even for window boxes. A 15 cm container will be sufficient to obtain a stack of sweet and healthy fruits.	7.89 \$ 20 s/p
65-9248-01N Sweet'N'Neat F1 Yellow	55		Small Det.	Yellow	25	Ultra compact cherry tomato, especially suited for patio containers and even for window boxes.	7.89 \$ 20 s/p
65-9227-01N Moncherry F1	58		Medium Indet.	Red	15	Candies in abundance! Moncherry produces a great yield of little red, sweet and juicy fruits on a vigorous plant.	7.89 \$ 10 s/p
65-9250-01N Pepe F1	58		Compact Det.	Red	15-20	A juicy cherry tomato with a high sugar content giving it an amazing sweet taste. Can be grown in the garden or in pots. Do not miss it!	11.09 \$ 20 s/p
65-9237-01B Jasper F1	60		Large Indet.	Red	10	AAS winner. This small tomato about 10 g, stands out for its distinctive flavor, smooth texture, holding ability, and overall garden performance (high yield). Jasper is tolerant to Mildew and Blight (Early and Late Blight).	7.89 \$ 15 s/p

TOMATO - SMALL FRUITED



Orangeto F1



Profi Frutti Cherry F1



Suncherry F1



Sun Gold F1



Toronjina F1

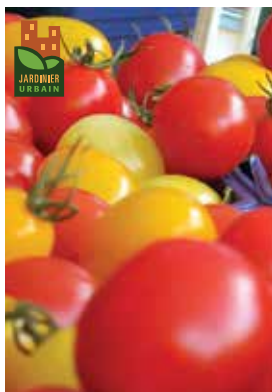

Small fruited Mix

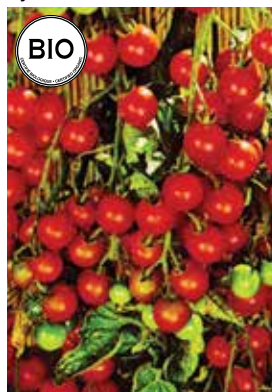

Sweet 100 F1



Sungreen F1



Sweet Gold F1

Variety Code	Maturity (days) ^T	Form.	Plant size	Colour	Fruit weight (g)	Variety Description	Price 1 Pkg
Tomato - Cherry							
65-9304-01N Orangeto F1	60	UNT EXCL.	Small Semi det.	Orange	20-25	Small, bright orange tomato that carries a gene that gives it a very good tolerance to late blight. The harvest of sweet and tasty fruits can thus go to the end of the season. Can be grown in-ground or in containers. 2020 All American Selection.	7.89 \$ 10 s/p
65-9288-01N Profi Frutti Cherry F1	60	UNT EXCL.	Large Indet.	Red	20	Indeterminate tomato selected for its excellent productivity. Small, dark red, shiny fruits that weight around 20 g. Profit Frutti Red has a Brix rate of 10 that make it a sweet and delicious treat.	7.89 \$ 10 s/p
65-9229-01N Suncherry F1	60	UNT EXCL.	Large Indet.	Red	Less than 25	A nice dark red cherry tomato that grows in a cluster supporting about 14 fruits. Tolerant to cracking. The plants are vigorous and the yield of sweet fruits is continuous.	7.89 \$ 20 s/p
65-9267-01N Sun Gold F1	60	UNT EXCL.	Medium Indet.	Orange	Less than 25	A succulent round deep orange cherry tomato with a delicious sweet taste. The indeterminate plant is extremely productive.	6.79 \$ 20 s/p
65-9274-01B Toronjina F1	60	EXCL.	Large Indet.	Orange	18-22	Vibrant orange and very sweet cherry tomato deliciously tasty. Gives high yield of very uniform fruits.	7.89 \$ 10 s/p
65-9264-01B Sweet 100 F1	63	EXCL.	Large Indet.	Red	Less than 25	Popular variety. Very sweet fruits with thick walls. Very productive.	5.69 \$ 20 s/p
65-9252-01N Sungreen F1	65	UNT EXCL.	Large Indet.	Green	Less than 25	Here is a green cherry tomato! You will need to be careful and watch for the change of skin color, from dark green to light green when ripe, then you know when to pick it. It has a crisp texture and its taste is slightly sour with a touch of citrus.	6.79 \$ 10 s/p
65-9265-010 Sweet Gold F.F.R. F1	65	TR EXCL.	Large Indet.	Yellow	Less than 25	Finally, an excellent yellow cherry tomato, that will bring some colour to your garden and salads! It has a great taste and doesn't crack.	5.69 \$ 20 s/p
65-9200-01N Small fruited Mix	60-65	UNT EXCL.	Med. Large Indet.	Mix	10-35	A mix meant for gardeners that are looking for diversity. This packet contains a red, an orange, a pink, a green and a black cherry tomato as well as the famous strawberry shaped tomato. The fruits produced will allow you to create colourful salads and dishes!	7.89 \$ 15 s/p



Sweet Million F1



Sweet Treats F1



Chocolate Cherry F1



Indigo Blue Berries



Apple Yellow F1



Apple Red F1



Mountain Magic F1



Sturdy Jo F1 Patio Collection



Indigo Rose

Variety Code	Maturity (days)	Form.	Plant size	Colour	Fruit weight (g)	Variety Description	Price 1 Pkg
Tomato - Cherry							
65-9266-010 Sweet Million F1	65		Large Indet.	Red	Less than 25	Highly noticed for its unique taste! Continuous flower set and fruit production all summer long. Produces fruits that are smaller in size than Sweet 100. The plant is strong and vigorous with high disease tolerance.	5.69 \$ 20 s/p
65-9268-01N Sweet Treats F1	65		Large Indet.	Pink	20-30	A unique cherry tomato with the distinctive taste of a pink tomato. Sweet Treats will provide the gardener with a complete eating experience: good aroma, perfect texture and a phenomenally sweet flavour. Fruits grow in clusters of 12-15 fruits per truss. Definitely a must.	7.89 \$ 10 s/p
65-9289-01N Chocolate Cherry F1	70		Medium Indet.	Red black	Less than 25	Improvement of the Black Cherry variety because of an increased tolerance to skin cracking. Chocolate Cherry has a rich red mixed with dark chocolate colour and a very sweet taste. For field, greenhouse or container production.	5.69 \$ 20 s/p
65-9278-01B Indigo Blue Berries	75		Large Indet.	Purple	25-50	The Indigo Blue Berries is as appealing to the palate and eye as its name implies. The plants produce trusses of delectable, little, 25 g - 50 g cherry tomatoes. The green fruit quickly develop purple tops and crimson bottoms, ripening to a midnight black tone. The fruit contains high levels of anthocyanins, a naturally occurring antioxidant (that reveals in the vibrant indigo pigmentation) reported combating disease. For the best sparkling flavour and texture, harvest when the colours have deepened.	7.89 \$ 10 s/p
65-9303-01N Apple Yellow F1	80		Large Indet.	Yellow	Less than 25	This AAS Winner offers incredible performance, a unique small apple shape with dimples, a lemony note in the taste and a fleshy, firm and meaty texture. The fruits are an eye-catching, bright, lemon-yellow colour with just the right balance of sugar and acid in a firm exterior.	7.89 \$ 10 s/p
65-9302-01N Apple Red F1	80		Large Indet.	Red	Less than 25	Just like its little yellow sister, Apple Red is characterized by its small dimpled apple shape, its fleshy and firm texture and its taste balanced in sugar and acidity. The yield of bright red fruit is very high, to the delight of gardeners.	7.89 \$ 10 s/p
Tomato - Cocktail							
65-9210-01N Mountain Magic F1	65		Large Semi-det.	Red	35	Excellent tasting Campari type cocktail tomato. Tolerant to cracking with a long shelf life. Fruit can also be harvested in clusters. Dark red fruit. A must in your garden!	6.79 \$ 15 s/p
65-9277-01N Sturdy Jo F1 Patio Collection	55		Large Det.	Red	25-30	A unique tomato that will adapt to various container sizes. It has a strong regrowth after the fruits are picked and can grow till 3 times its length. The skin is soft and the fruit is juicy. An interesting fact is that Sturdy Jo was known to be the sweetest in the world - testing required!	7.89 \$ 10 s/p
65-9235-01N Indigo Rose F1	75		Large Semi-det.	Purple	50	A cocktail tomato type that is eye-catching and has a good balance of sugars and acids. Indigo Rose is will stand out in your garden as well as in your dishes.	7.89 \$ 20 s/p

TOMATO - SMALL FRUITED



Sweet Valentine F1
Patio Collection



Tomatoberry Garden F1



Yellow Pear



Red Pear



Plumbrella Mix F1
Patio Collection



Juliet F1



Sun Dipper F1



Matthew F1



Sugary F1



Sweet Heart F1



Navidad II F1

Variety Code	Maturity (days) ^T	Form.	Plant size	Colour	Fruit weight (g)	Variety Description	Price 1 Pkg
Tomato - Strawberry							
65-9281-01N Sweet Valentine F1 Patio Collection	60		Small Det.	Rouge	10-15	Cute, small, heart-shaped red fruits on a small, well-branched, determinate plant. Sweet Valentine is perfect for pot cultivation or small planting areas.	7.89 \$ 10 s/p
65-9280-01N Tomatoberry Garden F1	60		Large Indet.	Rouge	10-15	Unique strawberry-shaped fruit! Fruit average 2,5 x 2,5 cm. Firm, chewy texture with an excellent sweet taste. Dark red colour. Plant with high yield.	7.89 \$ 10 s/p
Tomato - Pear							
65-9257-01N Yellow Pear	65		Small Det.	Jaune	Less than 25	Popular variety. Small, very sweet, yellow fruits, for pots or small planting areas. Most appreciated by amateur gardeners.	3.59 \$ 30 s/p
65-9259-01N Red Pear	65		Small Det.	Rouge	Less than 25	Popular variety. Small, very sweet fruits for pots or small planting areas. Flavourful.	4.59 \$ 30 s/p
Tomato - Plum							
65-9286-01N Plumbrella F1 Mix Patio Collection	65		Small Det.	Mix	15-20	A new genetic for patio tomatoes. The plum-shaped fruits of this determinate patio tomato will develop above the leaves and spread like a blanket for an attractive visual effect. The plant and leaves are heat tolerant. The deliciously sweet fruits ripe early and are easy to pick. Plant and fruiting habit make it an ideal variety to produce in containers or to use as in combos. Four colours in a packet: pink, red, orange and yellow.	7.89 \$ 10 s/p
Tomato - Grape							
65-9239-01N Juliet F1	60		Medium Indet.	Rouge	25-30	Variety of glossy dark red fruits, 4 cm long by 2 cm diameter. Unique sweet flavour and smooth texture. Tolerant to cracking. High yield.	5.69 \$ 20 s/p
65-9313-01N Sun Dipper F1	60		Large Indet.	Orange	30	Sun Dipper is an orange "dipper" tomato with an eye-catching elongated fruit that is easily held between fingers for dipping in dressing on a vegetable platter. The delicious, sweet fruits grow on an indeterminate plant that has good tolerances to diseases. An original addition to your garden.	7.89 \$ 10 s/p
65-9273-01B Matthew F1	60		Large Indet.	Orange	35	Grape tomato, orange in color, of large size can be compared to the Juliet variety. A unusual way to bring variety to your table.	7.89 \$ 10 s/p
65-9233-01N Sugary F1	60		Large Indet.	Rose	12-16	Unusual! Here is a proud little dark pink grape tomato that deserves its name. It contains 9.5 % more sugar than most other cherry type varieties. Superior high yield. Vigorous plants that may need pruning.	6.79 \$ 15 s/p
65-9272-010 Sweet Heart F1	60		Large Indet.	Rouge	Less than 25	Here is a versatile variety of tomato that can be grown in your garden or in a greenhouse. Remarkable for its tolerance to cracking and has a fabulous great taste.	7.89 \$ 15 s/p
65-9238-010 Navidad II F1	64		Small Det.	Rouge	Less than 25	Small but very sweet grape tomato. Navidad II Red has a compact and determinate plant and its fruits have increased tolerance capabilities to cracking. Coated seed	7.89 \$ 15 s/p



Sunrise Sauce F1



Pozzano F1



Granadero F1



Supremo F1



Mariana F1



Plum Regal F1



Marriage Perfect Flame F1
(Heirloom)



Little Napoli F1



San Marzano Marzito F1

Variety Code	Maturity (days) ^T	Form.	Plant size	Colour	Fruit weight (g)	Variety Description	Price 1 Pkg
--------------	------------------------------	-------	------------	--------	------------------	---------------------	-------------

Tomato - Italian

65-9218-01N Sunrise Sauce F1	60		Small Det.	Orange	85-100	The only orange Italian hybrid tomato on the market. Determinate plants are ideal for small-space gardens or large containers. It will produce easy-to-peel tomatoes, sweet and meaty, with a taste like traditional Roma. Sunrise Sauce yields large amounts at one time, enough to make a recipe of tomato sauce or salsa. It can be enjoyed fresh, but cooking will allow for all the flavors to come out.	7.89 \$ 20 s/p
65-9213-01B Pozzano F1	68		Medium Indet.	Red	150	A traditional looking "San Marzano" tomato that produces large tomatoes without green shoulders. The fruits are really full and have a good tolerance to blossom end rot.	7.89 \$ 10 s/p
65-9216-01B Granadero F1	68		Compact Indet.	Red	150	An Italian tomato tolerant to cooler conditions that produces a good yield of large fruits. Ideal for preparing sauces and cannings.	7.89 \$ 10 s/p
65-9211-010 Supremo F1	70		Compact Det.	Red	120-130	Early, large tomato that produces high numbers of extra-large, blocky, plum-shaped fruits. Compact plants have a concentrated production period and set well in the heat. High quality fruits are very firm. Nice red colour at maturity. Excellent for sauces. Coated seed	5.69 \$ 20 s/p
65-9226-01N Mariana F1	72		Small med. Det.	Red	125-130	Mariana is one of the widely used saladette types because of its wide adaptability, disease package and fruit uniformity. Plants offer good yields of fruits that have good smoothness and are uniformly ripening. Excellent choice for canning, salsas, sauces and juice.	7.89 \$ 20 s/p
65-9222-010 Plum Regal F1	73		Medium Det.	Red	120-130	Our first variety of Italian tomato resistant to mildew and late blight. Plum Regal has a beautiful dark red internal color and a fabulous flavor making it ideal for sauces or salsas. It is also crack resistant and the determinate plant will keep healthy in the garden. Coated seed	7.89 \$ 20 s/p
65-9215-01N Marriage Perfect Flame F1 (Heirloom)	75		Large Indet.	Orange	110-125	Orange saladette tomato with sweet-tart fruitiness. Perfect Flame is a cross of Peron x Flame and is the earliest-ripening Heirloom Marriage variety. It is best grown in-ground.	6.79 \$ 20 s/p

Tomato - Italian Mini

65-9243-01N Little Napoli F1	60		Small Det.	Red	30	One of the only patio romas, with disease resistance for better garden success. High yields for such a small plant – harvest enough at one time for a batch of salsa or sauce! Best grown in a container.	7.89 \$ 15 s/p
65-9271-01N San Marzano Marzito F1	60		Large Indet.	Red	25	Small tomato with an elongated shape that is reminiscent of a Roma fruit, which is great for cooking a quick sauce. The firm texture and rich, sweet flavour mean it can be eaten fresh like cherry and grape tomatoes. Great disease resistance. Best grown in-ground.	7.89 \$ 10 s/p



Balm Lemon



Mandarina



Emerald Tower (Genovese)



Emily (Genovese)



Everleaf (Genovese)



Fine Green



Greek



Helios (Lemon)



Large Genova Green



Rosie (Red)



SimplyHerbs Try Basil



Purple Ball

Variety Code	Form.	Plant height (cm)	Spreading (cm)	Variety Description	Price 1 Pkg
Balm					
67-1310-01N Balm Lemon	UNCL. EXCL.	30-80	40-50	This plant can reach 40 to 50 cm in height on erect stems. Balm leaves are small, lobe-shaped, serrated and have a lemony perfume. (Annual)	3.59 \$ 200 s/p
67-1311-01N Mandarina	UNCL. EXCL.	30-80	45	Very aromatic perennial with a high and spread plant habit. Oval green leaves with a gentle mandarin fragrance. (Perennial)	6.79 \$ 50 s/p
Basil					
67-1112-01N Emerald Tower (Genovese)	UNCL. EXCL.	60-90	20-30	Well-branched variety with short internodes that makes a beautiful towering plant with a huge harvest. Grows well in-ground, in containers and hydroponics. Emerald Tower will flower up to 10 to 12 weeks later than the standard basil. Traditional Genovese flavour. Dark green, glossy foliage and tidy habit that stands out in your garden. (Annual)	6.79 \$ 100 s/p
67-1117-01N Emily (Genovese)	EXCL.	30	30	New Genovese type dwarf basil particularly well adapted for containers. This basil was bred to have shorter stem lengths between nodes while keeping its large and aromatic leaves. Emily has a longer shelf life after harvest than most basil varieties, and keeps longer than most Genovese types under refrigeration. (Annual)	4.59 \$ 100 s/p
67-1113-01N Everleaf (Genovese)	UNCL. EXCL.	25-30	25-50	The first basil crossed to ensure a good harvest all season thanks to its very late bolting. Compact and well-branched variety with intense basil flavour. Intermediate tolerance to downy mildew and fusarium. (Annual)	4.59 \$ 100 s/p
67-1110-01N Fine Green	UNCL. EXCL.	20-30	25-30	A compact plant with small smooth leaves. (Annual)	3.59 \$ 100 s/p
67-1105-01N Greek	UNCL. EXCL.	25-50	25-50	Basil with the same characteristics as the bush basil but even more scented. The leaves vary in size from 2 to 10 cm. (Annual)	3.59 \$ 100 s/p
67-1125-01N Helios (Lemon)	UNCL. EXCL.	40-60	30	Basil with a rapid growth that produces small leaves. Has a pleasant taste of basil and lemon. (Annual)	6.79 \$ 100 s/p
67-1120-01N Large Genova Green	UNCL. EXCL.	20-30	25-30	Lovers of this fragrant and flavourful annual herb tell us this is our best selection! Its large, smooth leaves add a delicious Mediterranean taste to your sauces, soups and salads. (Annual)	3.59 \$ 100 s/p
67-1162-01B Rosie (Red)	EXCL.	25-30	25-30	Here is a new variety of dark red basil. A compact plant on robust stems. (Annual)	3.59 \$ 100 s/p
67-1100-01N SimplyHerbs Try Basil	UNCL. EXCL.	60-75	30-40	Here is an all-in-one pellet including 3 basil varieties; Genovese, red and serrated selections! This mix will allow you to easily and quickly create an assortment of basil plants. Each pellet contains 8 to 14 seeds. (Annual) Multi-seed coating	6.79 \$ 25 s/p
67-1165-01N Purple Ball	UNCL. EXCL.	30	25-30	Unique basil with a spherical shape, compact and bushy, that will grow 30 cm high. A bushy plant that fills itself with small dark purplish-purple leaves and no less purple tubular flowers. An original variety to grow in the kitchen or in the garden. 2018 Les Exceptionnelles Programm Winner.	5.69 \$ 100 s/p



Thai Siam Queen



Everleaf Thai Towers



Borage



Burnet



Catnip



Chamomile



Chervil Curled



Garlic Chives



Nelly



Basil Collection



Herb Garden Collection



Herbes de Provence

Variety Code	Form.	Plant height (cm)	Spreading (cm)	Variety Description	Price 1 Pkg
Basil					
67-1133-01N Thai Siam Queen	UNT EXCL.	60	60	Jolina is a Genovese basil with a spicy taste of Thai. This variety was bred to be more compact, so it can easily be used for pot production. Its dark green leaves are smaller than the usual Genovese varieties. Finally, Thai basil is usually more tolerant to diseases and Jolina benefits from this advantage as well. (Annual)	6.79 \$ 100 s/p
67-1131-01N Everleaf Thai Towers	UNT EXCL.	60-90	20-30	Gorgeous columnar basil plant that presents masses of green leaves with occasional purple flecks and soft purple stems. Its aromatic and vibrant licorice flavour complements any dish, especially in Thai cuisine. Late-flowering habit means huge harvests of flavourful leaves throughout summer. (Annual)	6.79 \$ 100 s/p
Borage					
67-1510-01N Borage	UNT EXCL.	45	30	Borage is a plant that can reach 80 cm in height. Its juicy leaves with a flavor of cucumber, has multiple uses, culinary, medicinal and cosmetic. It is also used to soften and cleanse the skin. It is rich in calcium and potassium. (Annual)	4.59 \$ 55 s/p
Burnet					
67-7211-01N Burnet	UNT EXCL.	20-30	30	A herb that offers as much a nutty taste as a cucumber taste. Use the leaves in vegetable or fruit salads. (Perennial)	5.69 \$ 75 s/p
Catnip					
67-6350-01N Catnip	UNT EXCL.	90-100	50-60	The leaves are used for teas and for seasoning. Cats adore it, garden pests hate it! A great companion plant for many vegetables. Cut down it makes excellent pest-deterrent mulch. (Perennial)	4.59 \$ 200 s/p
Chamomile					
67-1710-01N Chamomile	UNT EXCL.	40-50	15-20	Chamomile produces a multitude of flowers and is quite popular for tea infusions. (Perennial)	3.59 \$ 500 s/p
Chervil Curled					
67-2510-01N Chervil Curled	UNT EXCL.	40-50	20	Chervil is easy to grow and will bring you an abundant production if it sits in a humid soil, in the shade. It is quite appreciated in cuisine to complete many types of dish, such as soups, salads, sauces, meats, etc. (Annual)	3.59 \$ 200 s/p
Chives					
67-3120-01N Garlic Chives	UNT EXCL.	30-40	30	Flat, greyish-green leaves with a distinctive taste of garlic. (Perennial)	3.59 \$ 200 s/p
67-3116-01B Nelly	EXCL.	15-30	15-20	This chive has a nice dark blue-green color on a fine, to medium, stem. Vigorous and upright growth. Very tolerant to disease and thrips damages on leaves. (Perennial)	3.59 \$ 200 s/p
Collection					
67-0030-01N Basil Collection	UNT EXCL.	**	**	A collection of popular Basil. A collection contains one (1) packet of each: Rosie, Large Genova, Fine green, Greek and Lemon. (Annual)	16.59 \$ collection
67-0015-010 Herb Garden Collection	TR EXCL.	**	**	A traditional collection of popular fine herbs. A collection contains one (1) packet of each: basil, chervil, dill, marjoram, mint, oregano, sage, savory and thyme.	14.49 \$ collection
67-0020-010 Herbes de Provence	TR EXCL.	**	**	Prepare your own Provençal herb mixture that you can use fresh or dried in your favourite recipes. Included, is one (1) packet of each: large Genova green basil, oregano, rosemary, winter savory and winter thyme.	11.09 \$ collection



Italian Herb



Marino



Santo



Cumin



Dukat



Fernleaf



Dragon F1



Lavender Munstead



Lemongrass



Lovage



Marjoram Sweet

Variety Code	Form.	Plant height (cm)	Spreading (cm)	Variety Description	Price 1 Pkg
Collection					
67-0025-010 Italian Herb	TR EXCL.	**	**	Italian cuisine is with no doubt very delicious. With this unique collection you will succeed Italian recipes and to make your own pesto. The collection includes one (1) packet of each: large Genova green basil, marjoram, oregano, Italian dark green parsley and sage.	10.09 \$ collection
Coriander					
67-3556-01B Marino	EXCL.	60-100	25-30	Compact variety well adapted for production in containers. Marino is quick to emerge, grows vigorously, and resists to bolting. Abundant and fragrant harvests ahead! (Annual)	3.59 \$ 150 s/p
67-3551-010 Santo	TR EXCL.	40-50	75	Plants are bushier than the common variety. Slow to bolt. (Annual)	3.59 \$ 150 s/p
Cumin					
67-1912-01N Cumin	UNT EXCL.	45	30	The cumin seeds are mainly used as spice. Their flavour resembles that of the caraway seed but is more pronounced. Used in soups, breads, cheeses, it is a basic ingredient for making commercial curry powder. It is preferable to start cultivating cumin plants in a greenhouse because it requires warm conditions. (Annual)	4.59 \$ 100 s/p
Dill					
67-0510-010 Dukat	TR EXCL.	60-75	30	Grown for its pungent leaves and seeds. Has a uniform plant habit with larger umbels than other varieties. (Annual)	3.59 \$ 200 s/p
67-0511-01N Fernleaf	UNT EXCL.	40-50	30	A very unique variety for its extremely bushy plant, very close internodes and multiple secondary branches. The umbels are a long time in production. Mainly sold for its branches. (Annual)	3.59 \$ 100 s/p
Fennel					
67-4313-01N Dragon F1	UNT EXCL.	75	45	Dragon is a very round fennel, of medium to fast growth, very slow to bolt. With a dwarf habit and excellent resistance to heat and yellowing, Dragon can be grown in almost all conditions. Spread your sowings through late spring and into summer and you will harvest your own homegrown fennel bulbs right through to autumn. (Annual)	4.59 \$ 80 s/p
Lavender					
67-4911-01N Lavender Munstead	UNT EXCL.	30	60	A beautiful, early and compact lavender. (Perennial)	3.59 \$ 100 s/p
Lemongrass					
67-3202-01N Lemongrass	UNT EXCL.	60-100	30-60	We now offer you the very popular tropical herb favored in Thai cuisine, lemongrass. Not only is it widely used as a culinary herb but also as a medicinal herb in India. It has long, slender, pale green stems that are thick and fleshy with a subtle citrus flavor. Lemongrass can be dried and ground into powder or used fresh in soups, curries and stir-fries. This perennial must be grown in warm weather. (Perennial)	5.69 \$ 300 s/p
Lovage					
67-5310-01N Lovage	UNT EXCL.	100	150	Lovage has a celery-like growth; it can be eaten raw or blanched. Its leaves have a pleasant celery flavour. Sprinkle seeds over meat dishes or candies can also be used in the making cordials or lovage wines. Roots have medicinal qualities. (Perennial)	4.59 \$ 100 s/p
Marjoram					
67-5510-01N Marjoram Sweet	UNT EXCL.	20	15	Resembles oregano but with larger leaves. Is very useful in the kitchen: sprinkle on meat or vegetable dishes, use in salad dressings, etc. Also used as an insect repellent. Superior yield in humid, fertile soil in a very sunny area. (Perennial)	5.69 \$ 100 s/p



Peppermint



Spearmint



Cleopatra



Oregano



Oregano Greek



Astra (Curled)



Green Pearl (Curled)



Italian Dark Green



Bellezia



Rocket



Wasabi



Rosemary

Variety Code	Form.	Plant height (cm)	Spreading (cm)	Variety Description	Price 1 Pkg
Peppermint					
67-6321-01N Peppermint	UNT EXCL.	50-90	30-50	Bushy, well-branched plant with egg shaped elongated leaves with an intense flavour. Used by cooks, by herbalists and in the making of alcoholic beverages. (Perennial)	4.59 \$ 200 s/p
Spearmint					
67-6320-01N Spearmint	UNT EXCL.	30-60	40	One of the most popular mint because its leaves have a fruity, mild taste and great aroma. Mint is used in many culinary recipes. The plants are overrunning with stems that spread rapidly and widely. Flowers are purple at maturity. (Perennial)	4.59 \$ 200 s/p
Oregano					
67-6521-01B Cleopatra	EXCL.	25	25	This oregano has a pretty silver gray foliage appreciated for its ornamental beauty and flavor value. Cleopatra distinguishes itself from Greek and Italian oreganos by a mildly spicy flavor tinged with a fresh mint coolness. This compact, trailing plant produces a high yield of leaves that makes it a first rate container plant. AAS 2015 winner. (Perennial)	5.69 \$ 300 s/p
67-6510-01N Oregano	UNT EXCL.	20	15	Similar to Origanum majorana, but the taste is not as pronounced. (Perennial)	3.59 \$ 400 s/p
67-6520-01N Oregano Greek	UNT EXCL.	20	30-40	Its thick, oval shaped, furry leaves offer spicier flavour. (Perennial)	4.59 \$ 400 s/p
Parsley					
67-7131-01N Astra (Curled)	UNT EXCL.	25-40	30	Here is a deep green, triple curled parsley developed to be grown and harvested all season long. Can be used fresh, dried or frozen. (Annual)	3.59 \$ 100 s/p
67-7128-01B Green Pearl (Curled)	EXCL.	30-40	30	High quality variety densely filled with curly dark green leaves on strong stalks, ideal for garden and pot cultivation. (Annual)	3.59 \$ 100 s/p
67-7155-01N Italian Dark Green	UNT EXCL.	40	30	A productive selection with a more vigorous plant habit. Yields dark green, smooth leaves. (Annual)	3.59 \$ 100 s/p
Rocket (Arugula)					
67-8123-01B Bellezia	EXCL.	15	20	Arugula Bellezia is a beautiful variety with an impressive tolerance to downy mildew. Striking dark green and highly serrated leaves give Bellezia an elegant look. Excellent bolting tolerance, and excellent shelf-life. (Annual)	5.69 \$ 100 s/p
67-8110-01N Rocket	UNT EXCL.	15	20	Cultivated arugula, with a rich and peppery taste, without being too spicy. Good tolerance to bolting. (Annual)	5.69 \$ 100 s/p
67-8104-01N Wasabi	UNT EXCL.	15	20	Wasabi rocket is a new variety of small young shoots that will tickle your nose, such as the mustard bearing the same name. Its small leaves, with delicate serrated edges, are at the same time tender and spicy. It will give a «punch» to your recipes. (Annual)	5.69 \$ 100 s/p
Rosemary					
67-7910-01N Rosemary	UNT EXCL.	90 -150	90-150	Grayish-green, woody stems. Leaves are dark green on top and are white on the bottom, persistent, narrow, pointed and 2 to 3 cm long. Known for its spicy scent. The strong aroma of the leaves makes it a favourite choice in culinary, medicinal or other preparations. (Perennial)	5.69 \$ 180 s/p



Sage Broad Leaf



Summer Savory



Winter Savory



Sorrel French



Stevia



Dropshot



Tarragon Russian



Orangelo



Winter Thyme



Wormwood

Variety Code	Form.	Plant height (cm)	Spreading (cm)	Variety Description	Price 1 Pkg
Sage					
67-9110-01N Sage Broad Leaf	UNT EXCL.	75	50	Traditional seasoning for poultry stuffing, meats, sausages, omelettes, cheeses and bean dishes. It has attractive, light blue flowers. A sage plant will deter many insect pests, but will attracts bees. (Annual)	3.59 \$ 100 s/p
Savory					
67-8910-01N Summer Savory	UNT EXCL.	30	15	It has narrow dark green leaves with pale purple flowers making it a very nice plant for rock gardens and borders. (Perennial)	3.59 \$ 200 s/p
67-8920-01N Winter Savory	UNT EXCL.	35-40	30-40	It can be compared to Summer Savory, but with a more pronounced flavour. Leaves are greyish green, with beautiful white or pink flowers. Multiple culinary and medicinal uses. Very attractive as a mini shrub or border plant. (Perennial)	3.59 \$ 200 s/p
Sorrel					
67-6710-01N Sorrel French	UNT EXCL.	30-45	20-25	Large green leaves, very acid, slightly lemony taste. Used for soups, salads or in fish dishes. (Perennial)	4.59 \$ 100 s/p
Stevia					
67-9210-01N Stevia	UNT EXCL.	30-50	30-50	This is a unique and interesting herb, whose dried leaves can substitute for sugar in drinks, desserts and many other dishes. A delightful addition for your garden. (Annual)	6.79 \$ 40 s/p
Tagete					
67-9301-01N Dropshot	UNT EXCL.	25-30	25-30	Dropshot is an annual plant, part of the marigold family, that has insignificant flowers. The foliage has a sweet taste with a strong licorice or anise flavour. Dropshot, globular in shape, branches freely and produces a dense plant of fine, thin and tender leaves which can be used to flavour drinks, tea and food. Also great just chewed on its own. (Annual)	10.09 \$ 100 s/p
Tarragon					
67-3910-01N Tarragon Russian	UNT EXCL.	60-90	30-45	Dark green leaves on the top, lighter underneath, narrow and slightly pointed. Various culinary uses. Flavour is more pronounced than French tarragon. (Perennial)	3.59 \$ 400 s/p
Thyme - French					
67-9515-01N French Thyme Orangelo	UNT EXCL.	25-30	30-35	French Thyme with a traditional thyme fragrance and overtones of a citrusy orange scent. Orangelo is useful in the kitchen and quite interesting as a fragrant ground cover in the landscape, where it forms a low mat and spreads to cover the soil. During summer the plant fills itself with tiny white flowers. A hardy evergreen perennial that survives to USDA zone 5. It can be used in containers of all sizes, as ground cover, with perennials or makes an excellent filler component for mixed containers. (Perennial)	10.09 \$ 100 s/p
Thyme - Winter					
67-9510-01B Winter Thyme	UNT	25-45	20	Very small, dark green, elongated, oval leaves. Small flowers are from light purple to lilac. Multiple culinary and medicinal uses. Superior yield if cultivated on slanted, poor, rocky areas that are exposed to the sun. Tolerates dryness. (Perennial)	3.59 \$ 100 s/p
67-9510-01N Winter Thyme	UNT	25-45	20	Available in untreated seed. (Perennial)	3.59 \$ 100 s/p
Wormwood					
67-0310-01N Wormwood	UNT EXCL.	80-100	100-150	This attractive, silvery-grey absinthe plant makes an ideal background in a border. It is excellent as an insect repellent. (Perennial)	5.69 \$ 900 s/p

Our choices of books

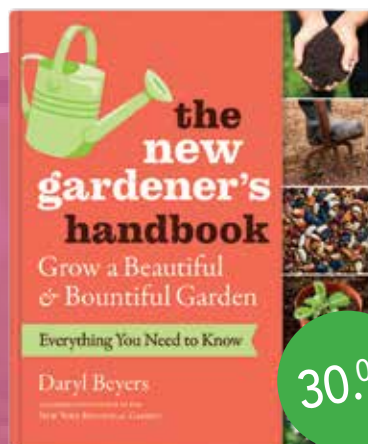

30.00\$

The New Gardener's Handbook is a comprehensive overview of the fundamentals of gardening, based on the introductory gardening class that Beyers teaches at NYBG. Readers will learn about soil, plant selection, propagation, planting and mulching, watering and feeding, pruning, and weeds, pests, and diseases. The information applies to both ornamental and edible plants. Featuring inspiring photography and helpful illustrations, The New Gardener's Handbook gives home gardeners a foundation upon which they can grow, and encourages them to apply the lessons they've learned in an intuitive, natural way. Author: Beyers Daryl Editor: Timber Press, 240 pages.

17-0022-010

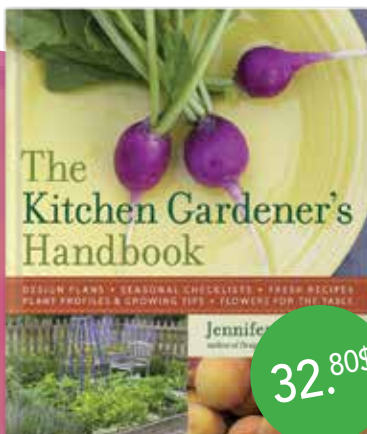

32.80\$

Gardeners are discovering the pleasures of incorporating edible and ornamental into their home landscapes. The Kitchen Gardener's Handbook makes it easy by showing how a well-designed landscape can yield both bounties for the table and beauty for the soul. Bartley's friendly advice gives gardeners the tools they need to build and maintain a kitchen garden. Readers will learn how to plant, grow and harvest the best vegetables, fruits, greens, and herbs for every season. They'll also find seasonal recipes, monthly garden chores, garden designs, and information on using cut flowers for decoration. Author : Jennifer R. Bartley Editor: Timber Press. 225 pages.

17-0021-010



30.00\$

The 500 best tricks of «The Laidback Gardener» Larry Hodgson, has selected not only 500, but 557 of the best tips from his bestseller «Les 1500 trucs du jardinier paresseux». These great tips are written to simplify gardening and lighten your tasks allowing you to make the most of your summer. Some advice is radical and will surprise you. In fact, you will be surprised not to have thought of these simple and easy-to-apply tips sooner. You will finally be able to sit down and admire your layout rather than working on it all the time! Auteur : Larry Hodgson. Editor : Broquet. 320 pages **French Version Only.**

17-0002-010



35.00\$

Growing vegetables in winter in a northern climate is possible! Based on years of research and experimentation, this beautifully illustrated practical guide presents a series of tips and tools to start your winter vegetable growing project. More than a simple instruction manual, Le maraîchage nordique is also a resolutely engaged work, proposing a new model of food security based on ecological, green and local agriculture. Authors: Jean-Martin Fortier, Catherine Sylvestre and Ricardo Larivée. Cardinal editions, 248 pages.

French Version Only.

17-0012-010

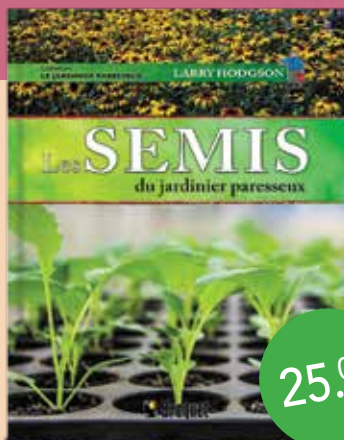

25.00\$

LARRY HODGSON presents the most comprehensive book on seedlings ever written in Québec. Whether it's for indoor or outdoor seedlings, ornamental plants, vegetables or herbs, he explains everything, from harvesting and saving seeds to sowing, always from the point of view of a laid-back gardener. Since each seed has its own needs, the author gives in the second part all the necessary indications to successfully grow 350 plants using seedlings. The overview includes annuals and common vegetables as well as perennials, biennials and herbs, which are often more complex. Sowing has never been easier. Larry Hodgson. Editor: Broquet. 224 pages.

French Version Only.

17-0008-010



32.00\$

This book is a great source of practical information on organic vegetable production. It is intended for home or professional gardeners farming on small areas. Author: Jean-Marc Fortier. Écosociété publishing. New revised and expanded edition. Auteur: Jean-Marc Fortier.

French Version Only.

17-0010-01F



Earthway Precision Garden Seeder

Léger et facile à utiliser, le semoir "Earthway" vous offre performance et durabilité. En un seul passage, il ouvre le sillon, espace et enfouit les semences, referme le sillon et compacte le sol. Il peut même tracer le rang suivant grâce à son marqueur pratique. Fait de matériel résistant, il n'y a que la poignée à mettre en place. Les plaques à semis pour les principaux légumes (maïs sucré, haricot, pois, radis, carotte, betterave) sont comprises. **Individual seed plates sold separately.**

1 unit (plate) 16.60 \$/each

A 06-5054-010 Earthway Precision Garden Seeder
1 unit 247.50 \$/each

B 06-5022-010 Sweet corn plate
 7.2 inch spacing in the row.

B 06-5023-010 Broccoli seed plate
 1 inch spacing in the row.

B 06-5024-010 Lima bean seed plate
 12 inch spacing in the row.

B 06-5026-010 Carrot, lettuce, cabbage and onion plate
 4.5 inch spacing in the row.

B 06-5030-010 Popcorn seed plate
 9 inch spacing in the row.

B 06-5038-010 Pea plate
 3 inch spacing in the row.

B 06-5040-010 Blank seed plate
 Create the spacing needed on the row.

B 06-5050-010 Radish, leek, asparagus and spinach plate
 3 inch spacing in the row.

B 06-5051-010 Bean and sweet pea plate
 3.6 inch spacing in the row.

B 06-5066-010 Cucumber plate
 9 inch spacing in the row.

B 06-5070-010 Beet and okra plate
 3.6 inch spacing in the row.

C 06-5901-010 Belt
 Earthway seeder spare belt.
1 unit 35.10 \$/each

Mini hand seeder

Made of very sturdy, transparent plastic. Easy to use. Its opening adjusts effortlessly to accommodate different seed sizes. Essential to avoid having to thin out seedlings.

06-5010-010 Mini hand seeder
1 unit 4.00 \$/each
3 units or more 3.60 \$/each



Magic Seeder

More accurate than the mini but as easy to use, the "Magic" seeder is perfect to distribute with precision both small and multipellet seeds in pots or in plug trays. (To open, use the tip of a small screwdriver).

06-5015-010 Magic Seeder
1 unit 19.80 \$/each
3 units or more 17.82 \$/each



Mini wand seeder

Perfect for the home gardener, this seeder can easily handle small, very small or large flowers or vegetable seeds without batteries or electrical power. Working with a hand vacuum bulb, seed is picked and released at the desired location. The set of five tips sizes for most seed groups and the magnified tip gives you a better view of the tiny seeds. The tip storage container lid also serves as a seed tray during sowing.

The set includes: one set of 5 tips, one magnifier tip, one 170 g vacuum bulb in a storage container. Detailed instructions are included.

06-5018-010 Mini wand seeder
1 unit 47.80 \$/each



Vibro hand seeder

This hand seeder is easy to use and allows an accurate and fast seeding... Cordless and water resistant, you can control the speed of the seed falling off by adjusting the control of the speed or tilting the seeder up and down. The seeds spread at the desired location saving you thinning time.

Powered by one 9 Volt battery. Detailed instructions and battery are included.

06-5016-010 Vibro hand seeder
1 unit 125.70 \$/each



Propagating Tray K1020P

These sturdy trays made of durable plastic are suitable for both home and commercial use. Their deep ribbed bottom and rolled rim edges increase their strength and make them easy to handle. They are designed to use Jiffy Peat Pellets, Cell-Packs, seedling trays or any other growing medium. Use as seed flats, transplanting flats, growing trays for plants, bulbs, etc. Without drainage holes.



Dimension : 2.52 x 11.44 x 21.84 inch

06-3041-050

Propagating Tray K1020P

1 unit (5 trays) 16.00 \$/each
3 units or more 14.40 \$/each



Vents dome

Use this tough plastic dome with your propagation tray K1020P. The tree (3) adjustable vents allows you to control the humidity and temperature.

A 06-3020-050 Vent dome of 2 inch

The 2 inch high dome will help retain moisture and heat to improve seedling germination.

1 unit (5 domes) 22.30 \$/each
3 units or more 20.07 \$/each

B 06-3025-050 Vent dome of 7.5 inch

The 7.5 inch high dome gives extra height to cuttings.

1 unit (5 domes) 42.70 \$/each
3 units or more 38.43 \$/each

Seed Starting Mix

Pro-Mix organic seed premium soil for seedlings that is ready to use. A peat-based mix with MYCOACTIVE technology to stimulate vigorous growth for greater stress resistance, stronger roots leading to healthier plants with greater resistance to transplant shock. Also formulated with coco fibre that helps manage moisture levels and protects roots from rot. Organic fertilizer that gradually feeds plants for up to 3 months. Ideal for germinating of vegetables, flower, herb seeds as well as for starting root cuttings.



02-4003-010

Premium Organic Seed Starting Mix 9 L

1 unit 8.40 \$/each 3 units or more 7.56 \$/each

Cells Seedling Tray

Practical size for starting vegetable or largers seeds. Sturdy tray made of moulded plastic. Each one of the cells has its own drainage hole. Reusable. Fits in propagation trays (code 06-3041-050).

Depth : 1.5 inch

A 06-3008-050

200 Cells Seedling Tray

1 unit (5 trays) 25.10 \$/each
3 units or more 22.59 \$/each

B 06-3009-050

288 Cells Seedling Tray

1 unit (5 trays) 25.10 \$/each
3 units or more 22.59 \$/each

C 06-3010-050

128 Cell Seedling Tray

1 unit (5 trays) 25.10 \$/each
3 units or more 22.59 \$/each



Cell-pack

The best way to have healthy young plants with minimum root disturbance. Individual cells in a light weight, reusable plastic tray. The cavity design has a slightly tapered shape that provides maximum soil and root capacity, yet permits easy transplanting with minimal root disturbance. All sizes fit in propagation trays (code 06-3041-050).

A 06-3003-050 8 sections of

4 cells, each (2.4 x 2.4 x 2.28 inch)

1 unit (5 trays) 12.60 \$/each
3 units or more 11.34 \$/each

B 06-3005-050 8 sections of

6 cells, each (2.4 x 1.6 x 2.28 inch)

1 unit (5 trays) 15.70 \$/each
3 units or more 14.13 \$/each

C 06-3007-050 8 sections of

9 cells each (1.6 x 1.6 x 2.28 inch)

1 unit (5 trays) 13.00 \$/each
3 units or more 11.70 \$/each

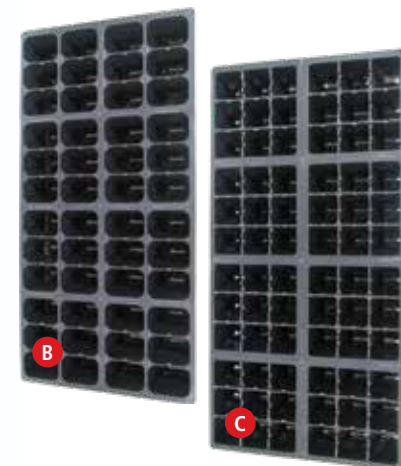

SEEDLING ESSENTIALS



CowPots

CowPots are made from composted cow manure: yes, cow manure! This exclusive process makes environmentally responsible containers respecting the environment sustainably and practically. The containers retain their shape for up to 12 weeks in a greenhouse setting. When planted in the ground, the decomposition process is well started within 3 to 4 weeks. Cow manure enables the natural decomposition of the containers. This decomposition process will save the plant from any stress related to transplantation and aid its adaptation to its new environment. Ecocert Canada approves CowPots as an input for organic agriculture.

- A** 06-2042-250 CowPots 4 inch (25/unit)
1 unit 20.50 \$/each 3 units or more 18.45 \$/each
- B** 06-2044-040 CowPots 3 inch packet of six (6) cells (4/unit)
1 unit 11.90 \$/each 3 units or more 10.71 \$/each



Plastic Containers

Shockproof. Flexible. Reusable. Manufactured from high quality, green polypropylene plastic. Durable and strong, designed to provide the best possible drainage for healthy, robust plant growth.

- A** 07-1074-100 Square 3.5 inch (10/unit)
1 unit 11.70 \$/each 3 units or more 10.53 \$/each
- B** 07-1082-100 Square 4 inch (10/unit)
1 unit 11.10 \$/each 3 units or more 9.99 \$/each
- C** 07-1158-100 Round 4 inch (10/unit)
1 unit 7.60 \$/each 3 units or more 6.84 \$/each
- D** 07-1162-100 Round 6 inch (10/unit)
1 unit 13.10 \$/each 3 units or more 11.79 \$/each

Jiffy Peat Pot

Inexpensive and environmentally sound "Jiffy Pots" are made from 75% sterile, odourless, long fibre compressed Canadian peat and 25% cellulose fibre for strength. Less watering is required because of the pot's superior moisture holding capabilities. "Jiffy A Pots" provide an ideal environment for root and plant growth. Plant roots grow right through pot walls permitting replanting without having to remove the pot!



- A** 06-2022-250 4 inch Round (25/unit)
1 unit 14.10 \$/each 3 units or more 12.69 \$/each
- B** 06-2034-250 3 inch Square (25/unit)
1 unit 9.40 \$/each 3 units or more 8.46 \$/each
- C** 06-2010-750 Jiffy 7 Peat Pellet (75/ unit)

An all in one growing medium! Convenient and easy to use, the sterile sphagnum peat includes a small amount of fertilizer and is enclosed in a neutral plastic netting that allows maximum root penetration. Place "JIFFY" pellets in a tray or other 2 inch deep container and add warm water. Each pellet expands up to 7 times its original volume (1.6 x 1.6 inch). All is neatly confined in the stretch net casing ready to receive the seed, seedling or leaf cutting.

- 1 unit 15.00 \$/each 3 units or more 13.50 \$/each

Coir container and pellets

Coconut palms grow new coconuts on a monthly basis, leaving the environment completely untouched. Peat, on the other hand, takes about 100 years to renew itself. This product line is made from a base of coconut fiber, provides greater resistance to mold, provides plants with faster growth and rehydrates easily requiring up to 30% less watering. Coconut fiber is an environmentally friendly alternative for a choice of growing media and pots. Made from 100% biodegradable organic material, these are more durable than peat and can be transplanted directly into your garden or planter.

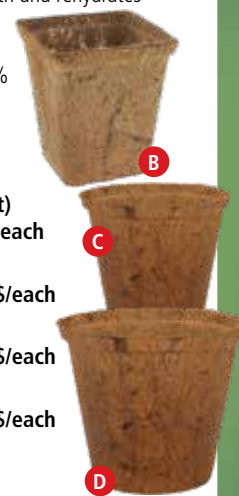

- A** 06-2051-250 Coir Pellets 42 mm (25/ unit)
1 unit 10.30 \$/each 3 units or more 9.27 \$/each
- B** 06-2053-200 Square 3.5 inch (20/unit)
1 unit 20.90 \$/each 3 units or more 18.81 \$/each
- C** 06-2054-200 Round 4 inch (20/unit)
1 unit 15.20 \$/each 3 units or more 13.68 \$/each
- D** 06-2056-200 Round 6 inch (20/unit)
1 unit 33.30 \$/each 3 units or more 29.97 \$/each

Tag

Rapiclip, eco-friendly wood labels to easily identify your flower or vegetable plants. Twenty-four (24) wooden labels (6" long) per pack.

- 06-2060-010
Rapiclip wood plant labels
1 unit 9.00 \$/each 3 units or more 8.10 \$/each



FIND A DROP-OFF POINT: the RecycFluo program drop-off points are there to help you recycle your bulbs containing mercury. <https://www.recycfluo.ca/en/>

Prismatic LED light Strip Equipment

Here is a more affordable upgrade to LED technology with higher efficiency. This produces up to 20% more light output through the use of a more efficient filter. The light passes through a prism which concentrates the light into a beam that has an angle of 90 degrees rather than 120 degrees like the old model. This technology ensures better light coverage on the plants which promotes faster growth. In addition, this system is practically silent and contains no mercury.

The equipment includes a 6400K LED strip with prismatic lens, a 6-foot power cord with a switch, a 14-inch link cord, two hanging and flat surface mounting clips.

06-1085-010 Prismatic LED light Strip Equipment - 2 ft kit

1 unit 61.00 \$/each 3 units or more 54.90 \$/each

06-1087-010 Prismatic LED Light Strip Equipment - 4ft kit

1 unit 86.80 \$/each 3 units or more 78.12 \$/each



LED Bulb T5

Improve your T5 lighting equipment by replacing its fluorescent bulb with an LED bulb. It adapts with the T5 kit structure and offers the same growth performance. Advantages: energy savings, contain zero mercury and extended life of approximately 50,000 hours.

06-1031-010 2 Feet T5 LED BULB

One (1) replacement bulb for 60 cm T5 Grow light system and the Grow light Garden 06-1080-010.

1 unit 25.90 \$/each 3 units or more 23.31 \$/each

06-1036-010 4 Feet T5 LED BULB

One (1) replacement bulb for 4 feet T5 grow light system and 4 feet Jump Start table grow light.

1 unit 39.30 \$/each 3 units or more 35.37 \$/each



Seedling Heat Mat

The heating mat warms the rooting area to improve germination and rooting. This mat is designed to increase the rooting area temperatures by approximately 10-20 °F above surrounding air temperature. Plugs into a 120-volt power source.

Length 20 inch Width 9 inch.

06-9020-010 Seedling Heat Mat

1 unit 39.10 \$/each 3 units or more 35.19 \$/each



Digital heat mat thermostat

A digital thermostat allowing you to select and maintain the optimal temperature for faster seedlings or crop growth. This thermostat is compatible with our seedling heating mat (code 06-9020-010). Simply plug both sets and push the 3-pin probe into the growing stand and set to the needed temperature. Thermostat temperatures range is between 68 °F to 108 °F.

06-9025-010 Digital heat mat thermostat

1 unit 47.80 \$/each 3 units or more 43.02 \$/each



Jump Start Soil Heating Cable (24 ft.)

This flexible cable fits virtually on any growing area. The built-in thermostat maintains a constant temperature of 25°-30°C (77°F-85°F), which accelerates germination and promotes strong growth.

Spread two inches of sand, then arrange the cables so that they are about 8 cm (3") apart. Add another layer of sand or soil to the desired depth (deeper for less heat, shallower for more). The area is then ready to be used as a permanent propagation table for seeds, seedlings and cuttings. The cables are designed to operate 24 hours a day. Complete instructions and safety precautions are included. (32W/120 V/0.27A).

06-9010-010 Jump Start Soil Heating Cable 24 ft

1 unit 54.60 \$/each

3 units or more 49.14 \$/each



FIND A DROP-OFF POINT: the RecycFluo program drop-off points are there to help you recycle your bulbs containing mercury. www.recycfluo.ca/en/

4 Feet Jump Start

The Jump Start light system is ideal for seedling or cutting, flowers, herbs and houseplants. The super efficient T-5 fluorescent light makes the plants grow faster by providing 15 to 20% more lumen than traditional grow lights. It features a simple toggle clamp for easy light adjustment and the fixture has an integral reflective finish that directs more light to plants. Super easy assembly. **In addition, there is a built-in timer.** Available in 4 feet lengths with 1 T-5 fluorescent bulb. **RecycFluo. Length 50 inch Width 18 inch Height 31 inch**



06-1048-010 4 Feet Jump Start
1 unit 116.50 \$/each

Mini Sunburst HPS 150W

This compact and easy-to-use luminary is perfect for the home gardener. The high-intensity bulb provides the spectrum of light required for a garden in the home or for small to medium-sized greenhouses. Easy to install and very quiet operation. It includes one (1) 150W bulb, one (1) 120V power cord 7 feet long, and two (2) hooks. **RecycFluo. Length 15 inch Width 7.38 inch Height 4.23 inch**



06-1070-010 Mini Sunburst HPS 150W
1 unit 114.50 \$/each

Bulb for HPS 150 Mini Sunburst

Replacement 150W bulb for Mini Sunburst light fixture 06-1070-010. **RecycFluo.**

06-1071-010 Bulb for HPS 150 Mini Sunburst
1 unit 24.10 \$/each 3 units or more 21.69 \$/each



T5 Lightning Kit with reflector and Fluorescent bulb

Cultivate with the T5 reflector and equipment. The reflector helps diffuse light widely through the plants without using extra power. It also reflects heat back into the growing area. This extends the life of the lamp and ballast. The T5HO equipment mimics natural sunlight, so it is ideal for plant and vegetative growth. It is self-ballasted and allows you to connect up to eight (8) fixtures with a single outlet. Suitable for residential or commercial use.

The equipment includes; 6400K grow light, reflector, ballast, six (6) feet long power cord, on / off switch, 14 inch link cord to connect multiple units, mounting and hanging clips. **RecycFluo.**

06-1054-010 2' T5 Lightning Kit with reflector and Fluorescent bulb

1 unit 39.60 \$/each
3 units or more 35.64 \$/each

06-1057-010 4' T5 Lightning Kit with reflector and Fluorescent bulb

1 unit 49.90 \$/each
3 units or more 44.91 \$/each



T5 Fluorescent Bulbs

They let you enjoy gardening every day of the year! Start your vegetables and flowers from seed or grow herbs for the kitchen, or even exotic plants. These fluorescent bulbs produce a full spectrum of light, using 20 % less electricity than old-type fluorescents. The light is also brighter (equivalent to 6400 Kelvin degree). **RecycFluo**

06-1032-010

2 Feet T5 Fluorescent bulb

One (1) replacement bulb for 2 feet T5 Grow light system and the Grow light Garden 06-1080-010. **RecycFluo**

1 unit 15.10 \$/each
3 units or more 13.59 \$/each

06-1034-010

4 Feet T5 Fluorescent bulb

One (1) replacement bulb for 4 feet T-5 grow light system and 4 feet Jump Start table grow light. **RecycFluo**

1 unit 15.70 \$/each
3 units or more 14.13 \$/each



CFL Bulbs

Designed for horticultural use, these full spectrum compact fluorescent bulbs provide natural color comparable to sunlight at lunch time, 6400 K. These bulbs are excellent for indoor greenhouse applications, where the sun's natural light is not available. They fit into a standard light socket and a variety of light fixtures such as table lamps, wall sconces and track lights. **RecycFluo.**

Life time of 10,000 hours.

06-1026-010 SunBlaster™ bulb 26 W

1 unit 11.90 \$/each

06-1025-010 4 SunBlaster™ bulbs 26 W

Set ensemble comprend 4 ampoules fluorescentes compactes SunBlaster™ 26 W 6400K.

1 unit 38.50 \$/each
3 units or more 34.65 \$/each



FIND A DROP-OFF POINT: the RecycFluo program drop-off points are there to help you recycle your bulbs containing mercury. www.recycfluo.ca/en/

Jardinière de croissance DEL

The Growlight Garden is the perfect tool for those who like to grow shoots, fresh greens or to start seedlings indoors!

The compact size and shape of this garden unit is ideal for a table or kitchen countertop. The sturdy recycled plastic base acts as a water tank. In its tray, an absorbent cloth covered stand draws the water up to the seedlings by capillarity. It includes four (4) reusable segmented trays for planting. Also, two (2) LED lamps are inserted in the curved reflective hood, flooding the growing area in full spectrum light. This system uses 20% less electricity than a traditional lighting system. The hood's height is adjustable so, once the seedlings sprout, you can lower it to about 4 inch from the top of the plants allowing them to grow bushy, strong, and compact. In addition, there is a built-in timer.

This unit measures 24 inch width x 14 inch depth x 17 inch height. All the components are made of 100% recycled plastic and complete instructions are included.



06-1082-010 Growlight Garden LED with timer

1 unit 264.40 \$/each

Contact W H Perron customer service for any replacement part.

Growlight Garden

It's the same model and measurements of the 06-1082-010. It includes four (4) reusable segmented trays for planting. Also, two (2) SunBlaster™ 6400 Kelvin T5HO fluorescent tubes are inserted in the curved reflective hood, flooding the growing area in full spectrum light. This system uses 20% less electricity than a traditional lighting system.



06-1080-010 Growlight Garden with timer

1 unit 201.20 \$/each

Contact W H Perron customer service for any replacement part.

7-day grounded digital programmable timer

It is very convenient to use a timer to automate your lighting, while constant light will promote growth. 7-day timer, programmable to the second. One (1) power outlet. Can open and close 8 times a day. Hours, minutes and seconds are adjustable.

06-1001-010

7 days grounded digital programmable timer

1 unit 25.50 \$/each 3 units or more 22.95 \$/each



Replacement mat

Replacement mat for the Growlight garden 06-1080-010 and 06-1082-010.

06-1081-010 Replacement mat

1 unit 14.90 \$/each 3 units or more 13.41 \$/each



Mini Greenhouse Kit

Mini Greenhouse makes propagation easy. It includes everything you need to start flower or vegetable seedlings, propagate fresh cuttings, or grow fresh herbs right in your kitchen all year long. Includes instructions and: 1 "SunBlaster™ NanoDome", a unique H pattern enabling you to lay your lighting across the dome. 1 "SunBlaster™ 18" T5HO lamp for indoor growing. 1 NanoTech Reflector that snaps into place, between the lamp and the ballast on the SunBlaster™ T5HO lamp. 1 "SunBlaster™ 1020 tray", twice as thick as standard trays, ensuring good durability to last season after season. **RecycFluo.**



07-1305-010 Mini Greenhouse Kit

1 unit 59.50 \$/ch 3 units or more 53.55 \$/each

Mini Greenhouse Kit LED

It's the same model, but uses less energy and the lights will last almost indefinitely. The LED bulb produce very intense light without consuming a lot of energy and it's friendlier to our environment since it contains zero mercury.



07-1307-010

Mini Greenhouse Kit LED

1 unit 79.30 \$/ch 3 units or more 71.37 \$/each

18 inch LED bulb 6400K

Replacement T5 bulb 18 inch for the mini greenhouse kit 07-1305-010/07-1307-010

06-1029-010 18 inch LED bulb 6400K

1 unit 22.40 \$/each 3 units or more 20.16 \$/each



18 inch Bulb T5 6400K

Replacement T5 bulb 18 inch for the mini greenhouse kit 07-1305-010. **RecycFluo.**

06-1030-010 18 inch Bulb T5 6400K

1 unit 12.40 \$/each 3 units or more 11.16 \$/each



2 ft Link cord

Here is a solution for connecting multiple T5HO equipment or LED light strips from a single power cord. You can connect up to eight units as needed with a single wall outlet. This connecting cord is a practical and ideal accessory to obtain the right distance between lights. Please note that this product is an "extra" cord. Each piece of equipment includes both a power cord and a connection cord.

06-1060-010 Link cord 2ft
1 unit 5.70 \$/each
3 units or more 5.13 \$/each



Reflector NanoTech T5

You want to maximize the performance of your T5 lighting system? The NanoTech T5 reflector is an ideal add-on. Super lightweight made of high-quality heat resistant PVC. Simply slide and snap in place into the case of the T5 base between the lamp and the base. Will capture 100% of previously wasted light reflecting 99% back into the target area. Provides more light without additional energy consumption.

06-1035-010 Reflector NanoTech T5 4 Feet
1 unit 14.90 \$/each
3 units or more 13.41 \$/each



Hang It Adjustable Hangers

These adjustable pulleys are sturdy with a suspension capacity of 75 lb each. Two pulleys are supplied per package for a combined capacity of 150 lbs. You can now hang your light over your grow area, with easy access to the height adjustment. The clip on the carabiners allows for easy installation and removal of your fixture.

06-1065-010 Hang It Adjustable Hangers (2/unit)
1 unit 14.70 \$/ch
3 units or more 13.23 \$/each



Light Grip-Suction Mount

The Light Grip Suction Mount is a handy device that allows you to attach your LED or T5 light to virtually any Humidity Dome or other smooth surface grow enclosure. Each set will support any length.

06-1063-010 Light Grip-Suction Mount (2/unit)
1 unit 11.00 \$/each
3 units or more 9.90 \$/each



Flush Mount Clips

They may be thin, but very sturdy metal clips. They will hold your lights firmly and take up virtually no space in your lighting installation. Allowing you to get the most plants underneath the lighting. Always use 2 clips per lamp for a secure and stable installation.

06-1062-010 Flush Mount Clips (4/unit)
1 unit 2.90 \$/each **3 units or more 2.61 \$/each**



Sunblaster™ universal light stand

SunBlaster's universal light stand securely holds each end of the grow lights with reflectors. Lights can be raised and lowered, and the bracket adapts to any size of T5 bulbs or LED. Easy to install, easy to move! The stand is easy to assemble, lightweight and portable.

It will keep your bulbs at a perfect distance from your seedlings so they can get the light they need for strong growth. The stand works well with 2 feet and 3 feet bulbs. **Beware it can be slightly unstable with 4 feet bulbs.**

06-1045-010 Sunblaster™ universal light stand
1 unit 44.20 \$/each **3 units or more 39.78 \$/each**



Light Strip Hanger

The Light Strip Hanger is the perfect accessory if you need more light above your culture. This can accommodate up to seven fixtures, either for the T5 or the LED. Lighting spacing may depend on your needs, but usually configurations are 2, 3 or 4 lights.

06-1064-010 Light Strip Hanger
1 unit 18.30 \$/each
3 units or more 16.47 \$/each

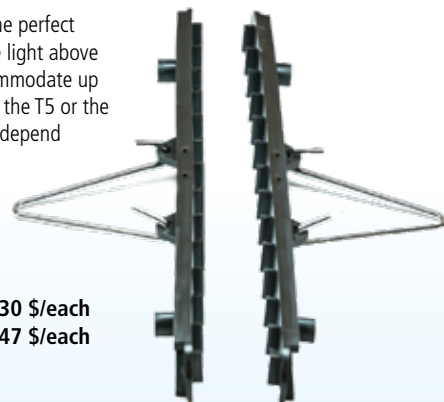



50 ft. Weeper hose (N)

Looking for alternatives to reduce your water consumption? The weeper hose is a solution that will give you highly efficient watering with minimal runoff, using up to 70% less water.

The material which it is made of is flexible, resistant to bending and very easy to handle. Plus, its flat design makes it easy to roll up and store after use. Ideal for vegetable gardens, shrubs and flowerbeds.

11-1340-010 Weeping hose 50'
1 unit 25.00 \$/each 3 units or more 22.50 \$/each

High wheel cultivator

This tool was especially intended to loosen the soil, dig the furrow and uproot weeds, all this with minimum effort on your part. In fact, its design almost completely eliminates the weight on the handles and ensures a better stability while doing the work. Made of heavy-duty tubular steel on a 2 feet wheel.



Three (3) interchangeable tools are included: one (1) 5-tine cultivator, one (1) twin end furrow plough and one (1) mould board plough.

12-7050-010 High wheel cultivator
1 unit 225.90 \$/each



Anchor Pins

Use to secure weed control fabric, turf, garden netting and other ground covers to soil. (10/unit)

07-1037-010 Anchor Pins
1 unit 5.00 \$/each
3 units or more 4.50 \$/each



"Velcro®" plant tie

The easiest way to support and to guide your plants. The "Velcro®" wraps onto itself for a secure hold. Adjust and reposition your plants as they grow. Strong, durable, weather-resistant and reusable.

Length 50 feet Width 1/2 inch.

13-8100-010 "Velcro®" plant tie
1 unit 9.40 \$/each
3 units or more 8.46 \$/each



Tree guard

Fits most trees: the size of the plastic grid protector is 30 cm x 60 cm. Durable material, made of high quality plastic, waterproof and moisture-proof, easy to fold and cut. Our plastic tree protection provides a good environment for tree growth.

13-5050-010
Tree guard 12 inch x 24 inch (4/pkt)
1 unit 10.00 \$/each
3 units or more 9.00 \$/each



Plant protecting fabric

This recyclable and UV treated blanket is a «must» in all gardens! Protecting plants against early spring and late fall frost, cold and freezing temperatures, it will also prevent insect damages. Easy to install, it provides 6 to 8° C of frost protection.

07-1031-010 Plant protecting fabric
Dimension: 10' X 16'

1 unit 16.00 \$/each
3 units or more 14.40 \$/each

07-1032-010 Plant protecting fabric
Dimension: 10' X 33'

1 unit 29.80 \$/each
3 units or more 26.82 \$/each

Anti-bird garden net

Here is a diamond-shaped net that will protect your crop against birds. Safe and environmentally friendly. It is made of a material that does not mould or burn, in addition to being treated against UV rays for better durability.

07-1015-010 Anti-bird garden net 13 ft x 13 ft

1 unit 14.90 \$/each
3 units or more 13.41 \$/each

07-1018-010 Anti-bird garden net 13 ft x 33 ft

1 unit 25.00 \$/each
3 units or more 22.50 \$/each



Bioprotect Fongicide for vegetable garden

Here is Bioprotect fungicide, made in Canada and approved for organic farming, for bacterial canker problems on tomatoes or powdery mildew on cucumbers, squash and pumpkins or powdery mildew and angular leaf spot on strawberries. It can be applied before or at the apparition of the symptom without any adverse effects against beneficial insects and pollinators. It is essential to follow the manufacturer's directions for use.

03-1002-010 Refill Fongicide Concentrated Bioprotect for vegetable garden (1 l)

1 unit 16.00 \$/each
3 units or more 14.40 \$/each

Net for climbing plants

Here is a net made of lightweight material, easy to handle and sturdy enough to support crops and climbing plants. Can be used as much for climbing plants, vegetables, fruits and flowers, such as loofah vines, grape vine, honeysuckle, morning glory, cucumber vine and more. In addition, it will allow you to cut and pick up your vegetables more easily.



07-1033-010 Net for climbing plants 6,5' X 13

1 unit 6.50 \$/each
3 units or more 5.85 \$/each



Insecticidal soap

Ready-to-use insecticidal soap based on potassium salts of fatty acids. Bioprotect Sôp controls effectively soft-bodied insects (aphids, whiteflies, mealybugs, spider mites, etc.) and earwigs. In addition, it does not contain alcohol which minimizes the risk of burning the leaves. Apply when insects first appear and repeat the treatment every two weeks. Spray both leaf surfaces and the stem.

03-1015-010 Bioprotect Sôp 1 liter ready to use format.

Made with potassium salts of fatty acids.
1 unit 11.00 \$/each
3 units or more 9.90 \$/each



Sprayer upside down 1000ml

A reversible sprayer that easily spray the underside of leaves!

11-1315-010

Sprayer upside down 1000ml
1 unit 8.00 \$/each
3 units or more 7.20 \$/each

Sunbubble Hothouse

Made from UV stabilized PVC and flexible fibreglass rods, its unique, patented, one-piece foldable design allows you to easily assemble and disassemble for simple storage. The innovative dome shape and its eight adjustable vents provide maximum light penetration and temperature control so your plants have optimal growing conditions.



07-1330-010 Small Sunbubble Hothouse (9' diam.)
Dimension; diameter 9 feet X height 6,5 feet
1 unit 299.50 \$/each



07-1325-010 Large Sunbubble Hothouse (11.5' diam.)
Dimension; diameter 11,5 feet X height 7,2 feet
1 unit 460.10 \$/each

Hothouse

Here is a compact greenhouse for those with less space or for beginner gardeners. Made with paint-coated tubular steel rods that snap together easily to form a sturdy, rust-resistant frame. The weather cover is made from heavy-duty polythene that resists robust weather and pest protection. Features two large side zippers for easy access. Ventilation is controlled using the insect-proof flaps at either end. Creates a faster-growing environment by retaining heat and moisture. You can grow seedlings, cuttings and young plants.



07-1315-010 Heat reflector greenhouse 3.2 ft
Dimension - 3.2 ft length x 1.6 ft width x 1.6 ft height
1 unit 49.90 \$/each

Anti-Insect Net

A flexible and light net with very fine mesh which will protect your plants against insects, birds, small animals, wind, rain and hail. Direct installation on the plants or the hoops (not included).



07-1034-010 Anti-Insect Net White 4,6' X 16,5'
1 unit 11.40 \$/each 3 units or more 10.26 \$/each

CROP PROTECTIONS



Tunnel felt fabric

Smaller, it is made of felt fabric and offers protection against small insects, protects against bad weather and creates a micro climate.

Dimension: Length 10 feet Width 1.5 feet Height 1 feet.

07-1029-010 Tunnel felt fabric

1 unit 29.90 \$/each 3 units or more 26.91 \$/each



Large polythene tunnel

This polythene tunnel provides robust protection against bad weather and pests for your winter and early spring crops.

Dimension: Length 10 feet Width 2 feet Height 1.5 feet.

07-1026-010 Large polythene tunnel

1 unit 41.60 \$/each 3 units or more 37.44 \$/each



Large micro net tunnel

This micro net tunnel for a vegetable garden offers effective protection against small insects, protects against bad weather and creates a microclimate.

Dimension: Length 10 feet Width 2 feet Height 1.5 feet.

07-1027-010 Large micro net tunnel

1 unit 48.80 \$/each 3 units or more 43.92 \$/each

Set of 2 slug traps N

You need to combat infestations of snails and/or slugs? Here's a simple, easy-to-use, safe and reliable trap. Put a beer bait in it and it will attract the undesirables. A set of two traps will protect an area of approximately 20 to 50 square metres. The traps are environmentally friendly, as they won't harm your garden with poisons. They're made of weather-resistant plastic.



08-0118-010 Set of 2 slug traps

1 unit 12.50 \$/each 3 units or more 11.25 \$/each

Micromesh Pest and Wind Barrier

Made of tightly woven, ultra-fine 0.6mm mesh, the pest barrier is ideal to protect any plant from pesky pets, harsh winds and low-flying insects. The sun can still shine on your crop, and you can still water and tend to it. Includes 2 lengths of 10 feet x 2.2 feet and bamboo sticks.



**Dimension: Length: 10 feet
Width: 3.2 feet Height: 2.2 feet.**

07-1025-010 Micromesh Pest and Wind Barrier

1 unit 44.60 \$/each 3 units or more 40.14 \$/each

Tomato protection

Its secret is the water that is poured in the plastic tubes, almost 12 litres, to retain heat, activate growth and insulate young plants from spring frost. Protection guaranteed to minus -12 °C. "Kozy Coats" can even be installed before you plant in the spring, for a faster warming of the soil. Made of strong, re-usable plastic.



WHY IS IT RED? Because studies done by an American University demonstrated that the colour red contributes to the production of larger, earlier fruit! Beware of less expensive, but less durable, imitations.

Dimension: 18 inch tall and when filled with water 12 inch in diameter on the inside.

13-9023-030 Kozy-Coats Tomato Protection (3/unit)

1 unit 19.30 \$/each

3 units or more 17.37 \$/each

13-9023-100 Kozy-Coats Tomato Protection (10/unit)

1 unit 64.30 \$/each

3 units or more 57.87 \$/each

13-9025-010

Repair sleeves Kozy-Coat Tube Inserts (10/unit)

Increase the life of your Kozy Coat with easy-to-use repair sleeves.

1 unit 6.90 \$/each

3 units or more 6.21 \$/each



Pot-It plant sticky insect traps

Double sided sticky insects traps, butterfly (4) and flower (4) shapes (8 pcs/pack). Ideal for house plants, gardens and greenhouses.
Size 2.4 x 2.4 inch.

08-0107-010

Pot-It plant sticky insect traps

1 unit 5.50 \$/each
3 units or more 4.96 \$/each



Fruit fly trap

Chemical free, easy to use and decorative, use it to bait fruit flies into the apple by using a ripe fruit. The fruit flies go into the apple and then they are unable to escape. Simply wash and re-use.

08-0110-010 Fruit fly trap

1 unit 8.80 \$/each
3 units or more 7.92 \$/each



Wasp Trap

An ecological trap designed with two holes to capture wasps. Simply add a small amount of juice, lemonade or beer and hang it in your garden or on a balcony. You can hang your trap or place it on a flat surface.

Two (2) traps per package.

08-0123-010 Wasp be gone

1 unit 10.00 \$/each
3 units or more 9.00 \$/each



Japanese Beetle Trap

This trap is designed to attract and capture adult Japanese beetle (Popillia japonica) on lawns, trees, shrubs and in gardens. It contains 2 types of bait for increased effectiveness: a floral scent to attract males and females and a sex pheromone to attract males. Use the trap from mid-June to mid-August when adult Japanese beetles are active. To maximize effectiveness, place the trap 10 ft from where the Japanese beetles are found, 3 ft off the ground, and facing the wind. The trap is reusable and the bait is designed for a full season.

Renew only the bait the following season (08-0117-010).

A 08-0116-010 Bioprotec Japanese Beetle Trap

1 unit 42.60 \$/each
3 units or more 38.34 \$/each

B 08-0117-010 Pheromones
Bioprotec Japanese Beetle 100 g

1 unit 12.60 \$/each
3 units or more 11.34 \$/each



Glass Hummingbird Feeder

A brightly coloured feeder that attracts hummingbirds with a built-in ant moat. The base disassembles for easy cleaning. Hang a bright red ribbon or bow from your feeder to increase hummingbird activity. Ten (10) oz. of nectar capacity. Regularly clean the feeder with a mixture of hot water and vinegar, rinse and air dry.

08-0142-010

10 oz. Glass Hummingbird Feeder

1 unit 11.90 \$/each
3 units or more 10.71 \$/each



Butterfly feeder

Butterflies react favourably to yellow colour and flower shaped objects. The feeder is equipped with an ant proof device and have wicks that draw in the nectar in order for the butterflies can feed themselves and cavities that can be used for the jelly, pieces of banana or ripe fruit pieces. The bright yellow polycarbonate feeder is dishwasher safe and the top part can be removed for cleaning.

Dimension: 7 inch diameter x 8.9 inch height. Capacity : 266 ml.

08-0145-010 Butterfly feeder

1 unit 15.90 \$/each
3 units or more 14.31 \$/each



Wreath Peanut Feeders

This unique easy access peanut feeder attracts jays, woodpeckers and other peanut loving birds. Good for suet balls or nesting materials, it can also be used for live plants, mosses. Very pretty when decorated with a bow for the holiday season. Made in metal.

Dimension:

Width 12.5 inch - Height 12.5 inch.

08-0140-010 Wreath Peanut Feeders

1 unit 19.00 \$/each
3 units or more 17.10 \$/each



Wasp bee gone

You want to avoid wasp nest in your backyard ! Try this artificial nest. Wasps and hornets are territorial insects and will leave the area of an unfamiliar nest.

Includes 2 PVC artificial inflatable wasp nests.

08-0120-010 Wasp be gone

1 unit 9.60 \$/each
3 units or more 8.64 \$/each



PATIO CONTAINERS

Specially designed for patios, balconies, or small gardens, these Patio Planters make it easy for you to enjoy the taste of homegrown vegetables, fruits, salads and herbs.

Potato patio planter

Now you can grow delicious homegrown potatoes, whether or not you have a garden. This tough bag is made of coloured polyethylene with reinforced drainage holes at the base, and handles on each side. No need for digging.

Dimension:

14 inch diameter x 18 inch height.

07-1010-010 Potato patio planter (3/unit)

1 unit 18.80 \$/each
3 units or more 16.92 \$/each



Moisture and pH meter

Here is a 2 in 1 device that measures the pH and humidity of your substrate in the garden, in planters and indoor pots. Use the moisture meter to avoid excess or lack of water by checking its content in the soil before watering your plants. Test the pH, as some plants need a precise level of it to grow and flower which will help guide your choice on fertilization needs. In addition, it can be a good tool to help you choose the right plants for your garden, by verify its pH.

04-1010-010 Bendable Coir Pole™ 30"

1 unit 14.90 \$/each
3 units or more 13.41 \$/each

3 sizes vegetable patio planters

This product contains three (3) planters of different depths: deep, medium and shallow, ideal for different types of vegetables. Made of a tough polythene with reinforced drainage holes and handles on each side, they fold flat for easy storage and can be used again, and again.

Dimensions: Deep = 14 inch diameter x 18 inch height, Medium = 16 inch diameter x 12 inch height, Shallow = 18 inch diameter x 10 inch height.

07-1023-010

3 sizes vegetable patio planters

1 unit 17.60 \$/each
3 units or more 15.84 \$/each



Wall planter

A hanging planter with 8 pockets, for various plantings, that will substantially increase any planting area. Useful in small gardens, roof tops, terraces, patios, and balconies. Very resistant, this planter is made of top quality UV-stabilized Oxford polyester fabric with reinforced eyelets. The tough Oxford fabric will help keep moisture, and the drainage holes will prevent over-watering. The lightweight planter can be hanged on fences or walls using standard screws or hooks. Easy to clean and to fold away when not in use.

Dimension: Width 24 inch - Height 19 inch

13-9045-010 Wall planter

1 unit 19.90 \$/each
3 units or more 17.91 \$/each

Large Patio planter

This large, rectangular planter is ideal for bigger garden space. **Dimension: 17 inch wide x 40 inch length x 10 inch height.**

07-1022-010 Large Patio planter

1 unit 14.90 \$/each
3 units or more 13.41 \$/each



“Root Pouch”

Grow your tomato, sweet pepper, herbs or strawberry plants in the “Root Pouch” pots. Winner of the “People’s Choice” award at the “Landscape Ontario” exposition in Toronto, this new technology uses recycled plastic bottles to create plant pots. In addition to being a more environmentally sound option, they are also sturdy, washable, lightweight and reusable. They have a 4 to 5 year degradable life span. More breathable and water efficient they encourage healthier root growth. Ideal for herbs, strawberries and other small plants.

07-1040-010 3 gallons

Ideal for herbs, strawberries and other small plants.

Width 10 inch Height 8.5 inch.

1 unit 3.80 \$/each

3 units or more 3.42 \$/each

07-1041-010 5 gallons with handles

Ideal for tomato, sweet pepper or similar size plants.

Width 11 inch Height 10.25 inch

1 unit 6.50 \$/each

3 units or more 5.85 \$/each

07-1042-010 7 gallons with handles

Ideal for large plants.

Width 14 inch Height 11.75 inch.

1 unit 8.10 \$/each

3 units or more 7.29 \$/each

07-1043-010 10 gallons with handles

Ideal for a wide range of crop varieties.

Width 16 inch Height 12 inch.

1 unit 9.00 \$/each

3 units or more 8.10 \$/each

07-1045-010 15 gallons with handles

Ideal for a wide range of crop varieties.

Width 17 inch Height 15 inch.

1 unit 12.30 \$/each

3 units or more 11.07 \$/each



Garden maypole decorative plant support

For a beautiful living maypole in your garden. Once assembled, all you have to do is sow or transplant your choice of climbing plants at the foot of each of the eight ropes (for example; sweet peas, clematis or Spanish beans). The set includes a black powder-coated steel pole and eight rot-resistant polypropylene strings, as well as galvanized steel stakes.

Dimension: 3.3 feet diameter x 6.3 feet height.

13-9040-010 Garden maypole decorative plant support

1 unit 19.90 \$/each

3 units or more 17.91 \$/each



Bendable Coir Pole™

We present you the Bendable Coir Pole™ that will give new life to your plant.

This will provide the perfect support for climbing plants, vine plants or hanging plants. Made in Canada by Mossify. Manila coir is all natural, with no added dyes or chemicals.

13-9046-010 Bendable Coir Pole™ 30"

1 unit 28.40 \$/each

3 units or more 25.56 \$/each



FERTILIZER AND SOIL AMENDMENTS



Soil Activator

Soil activator is composed of a unique blend of microorganisms naturally found in the soil. They help increase yield by improving the availability of the soil's nutrients. It will allow for better assimilation and availability of nutrients as well as improving water retention in the soil. Apply preferably at the time of seeding or planting. **Organic certified by Ecocert Canada.**

02-0404-010 Soil Activator 425 g

Mix with soil: 425 g treats up to 350 litres of soil. Mix with soil at seeding or transplant. Mix with water 425 g treats an area up to 4575 p² of flower bed.

1 unit 34.60 \$/each 3 units or more 31.14 \$/each

02-0405-010 Soil Activator 50 g

Mix with soil: 50 g treats up to 40 litres of soil. Mix with soil at seeding or transplant. Mix with water 50 g treats an area up to 538 p² of flower bed or 80 - 10 cm containers. Mix with at least 4 litres of water and apply to soil at the base of plants.

1 unit 7.20 \$/each 3 units or more 6.48 \$/each

Pro-Mix Root Booster

Discover PRO-MIX root booster 5-15-5 which contains two (2) growth hormones that will help a rapid development of vigorous roots. High phosphorus formula helps reduce transplant shock. Ideal for transplants, trees, shrubs, perennials, seedbeds, cuttings, garden vegetables and herbs.

Concentrated liquid.

02-4005-010

Root Booster 05-15-05

**1 unit (1 l) 15.10 \$/each
3 units or more 13.59 \$/each**



Sea Magic organic fertilizer

Made from seaweed that comes from the cold waters of the Canadian North Atlantic coast (Ascophyllum nodosum). 'Sea Magic' is a powder concentrate that you dilute in 4 litres of water to produce a liquid concentrate. You will then mix this concentrate with water, as needed, to produce 200 litres of liquid seaweed fertilizer. 'Sea Magic' promises to give you a better yield, tastier fruits and vegetables, fewer insects and diseases, and several other advantages.

Organic certified by Ecocert Canada.

02-4010-010 Sea Magic organic fertilizer

**1 unit (30g) 11.30 \$/each
3 units or more 10.17 \$/each**

Natural fertilizer

Layer hen manure has been recognized for centuries as one of the best natural fertilizers for the garden. Approved for organic agriculture by Ecocert Canada This new fast-acting fine sprinkle-on fertilizer is highly effective and easy to use.

02-4020-010 4-3-7 Annual fertilizer

**1 unit (350g) 9.90 \$/each
3 units or more 8.91 \$/each**

02-4021-010

4-2-8 Vegetable and fine herb fertilizer

**1 unit (350g) 9.90 \$/each
3 units or more 8.91 \$/each**



Soil Moist granules

Decrease the need to water your plants by 50%! "Soil Moist" crystals, when mixed in with the soil, act as water reservoirs releasing the water to plants as required. These little crystals store up to 200 times their weight in water and help to maintain vigorous plants even in dry periods. Non-toxic, safe and economical to use.

05-3020-010 Soil Moist granules

**1 unit (200g) 19.70 \$/each
3 units or more 17.73 \$/each**



INDEX

ANNUAL

A	
AGERATUM.....	25
ALYSSUM.....	25
AMARANTHUS.....	22
ANGELONIA.....	25
ANISE-HYSSOP.....	25
ASARINA.....	25
ASTER.....	28
B	
BABY'S BREATH.....	32
BACOPA.....	42
BEGONIA.....	26-27
BIDENS.....	27
BLACK-EYED SUSAN.....	42
BLANKET FLOWER.....	31
BUNNY TAIL.....	23

C

CALENDULA.....	27-28
CALIFORNIA BLUE BELLS.....	40
CANNA.....	28
CAPE DAISY.....	36
CASTOR BEAN.....	24
CAT GRASS.....	23
CELOSIA.....	28
CARDOON.....	24
CLEOME.....	30
COLLECTION ANNUAL.....	54-55
COLEUS.....	23
CORNFLOWER.....	28
COSMOS.....	27
CORSICAN MINT.....	23
CUPHEA.....	30
D	
DAHLIA.....	14, 30
DIANTHUS.....	31
DICHONDRA.....	23

DRACAENA.....	23
DUSTY MILLER.....	24

E - F

EUPHORBIA.....	31
FLAX.....	35
FLOWERING TOBACCO.....	36
FOUR O'CLOCKS.....	35

G - H - I - J

GAZANIA.....	31-32
GAURA.....	31
GERANIUM.....	37
GLORIOSA DAISY.....	41
GOMPHRENA.....	32
GUM TREE.....	14, 23
GYPSOPHILA.....	32
HYPOESTES.....	15
IMPATIENS NEW GUINEA.....	34
IMPATIENS WALLERIANA.....	34
JUNCUS.....	15

K - L

KALE - FLOWERING.....	22
KALE - PALM.....	22
LOBELIA.....	16, 35
LOVE-LIES-BLEEDING.....	22

M - N - O

MARIGOLD.....	43
MORNING GLORY.....	34
NASTURTLUM.....	44
NEMOPHILA.....	35
ORNAMENTAL MILLET.....	24
OSTEOSPERMUM.....	36

P

PANSY.....	45
PENNISETUM.....	24
PETUNIA.....	17, 38-40
PETCHOA.....	38
PHLOX.....	40
POPPY.....	36

PTILOTUS.....	36
---------------	----

R - S

RICE.....	24
RICINUS.....	24
RUDBECKIA.....	41
SALVIA.....	41-42
SHISO.....	36
SNAPDRAGON.....	16, 25
STRAWFLOWER.....	32
SUNFLOWER.....	32-33
SWEET PEA.....	35

T - V - W - Z

TAGETES.....	43
TICKSEED.....	30
TREE MALLOW.....	35
VERBENA.....	45
VINCA.....	45
VIOLA.....	45
ZINNIA.....	46-47

BIENNIAL & PERENNIAL

A-B

ALCEA (BIENNIAL).....	48
ASTILBE.....	48
BABY'S BREATH.....	51
BEEBALM.....	52
BELLFLOWER.....	48
BLANKET FLOWER.....	49

C - D

CHINESE LANTERN.....	52
CINQUEFOIL.....	52
COLLECTION PERENNIAL AND WILDFLOWER.....	54-55
COLUMBINE.....	48
CONEFLOWER.....	49-50, 52-53
CREeping THYME.....	53
DAISY.....	51
DELPHINIUM.....	48-49
DIGITALIS.....	49

E - F - G - H - K

ECHINACEA.....	49-50
FORGET-ME-NOT (BIENNIAL).....	52
GENTIAN.....	49
HELENIUM.....	51
HENS & CHICKS.....	53
HIBISCUS.....	51
HOLLYHOCK (BIENNIAL).....	48
KNIPHOFIA.....	51

L - M - P

LAVANDER.....	51
LUPINE.....	51
MEXICAN HAT.....	52
MILKWEED.....	48
MONEY PLANT (BIENNIAL).....	51
MUSK MALLOW.....	52
POPPY.....	52

R - S - T - Y

RATIBIDA.....	52
ROSE MALLOW.....	51
RUDBECKIA.....	52-53
SALVIA.....	53
SEDUM.....	53
SNEEZEWEED.....	51
SWEET PEA.....	51
YARROW.....	48
WHITE CLOVER.....	53

FRUITS AND VEGETABLES

A

ARTICHOKE.....	88
ASPARAGUS.....	88

B

BEET.....	72
BROCCOLI.....	3, 74
BROCCOLI MINI.....	74
BEANS - BROAD.....	69
BEANS - POLE.....	69
BEANS - SHELL.....	69
BUNCHING ONION (SEEDS).....	91
BUSH BEANS - GREEN.....	71
BUSH BEANS - PURPLE.....	6, 70
BUSH BEANS - YELLOW.....	70
BRUSSEL SPROUT.....	74

C

CABBAGE.....	73
CANTALOUPE.....	90

CARROT.....	76-77
CAULIFLOWER.....	3, 74
CELERIAC.....	88
CELERY.....	88
CHICORY-ITALIEN RADDICCHIO.....	84
CORN SALAD.....	85
CRESS.....	84
CUCUMBER.....	78-79

D - E

ECHALION (SEEDS).....	91
EGGPLANT.....	83

F

FRENCH SHALLOT (SEEDS).....	88
-----------------------------	----

G

GREENHOUSE VEGETABLES.....	68
GROUND CHERRY.....	88

H

HOT PEPPER.....	93
-----------------	----

K

KALE.....	75
KOHLRABI.....	75

L

LEEK.....	89
LETTUCE - BUTTERHEAD.....	86
LETTUCE - CRISPHEAD.....	87
LETTUCE - LEAF.....	86
LETTUCE - MESCLUN.....	87
LETTUCE - OAK LEAF.....	86
LETTUCE - ROMAINE.....	7, 87
LUFFA.....	99

M

MELON.....	90
------------	----

O

OKRA.....	89
ONION (SEED).....	91
ONION SETS (BULB).....	65
ORIENTAL VEGETABLES.....	85
ORNAMENTAL GOURD.....	97

P

PARSNIP.....	89
PEA.....	92
PEANUT.....	88
PEPPER - SWEET.....	94-95
PICKLING CUCUMBER.....	79
POP CORN.....	82
POTATO (BULBS).....	64
POTATO (SEEDS).....	89
PUMPKIN.....	4, 96-97

R

RADISH.....	101
ROCKET (ARUGULA).....	85, 113
RHUBARD.....	89
RUTABAGA.....	89

S

SALSIFY.....	89
SHALLOT (BULBS).....	65
SNAP PEA.....	92
SOYA EDAMAME.....	89
SPINACH.....	6, 84

SQUASH - SPAGHETTI.....	98
SQUASH - SUMMER.....	98-99
SQUASH - WINTER.....	5, 100
STRAWBERRY.....	62-63
SWEET CORN - BICOLORE.....	80-81
SWEET CORN - YELLOW.....	82
SWISS CHARD.....	84

T

TAPE SEEDS.....	8
TOMATO.....	7, 102-109
TURNIP.....	88-89

W

WATERMELON.....	90
WATERMELON - POLLINATOR.....	90

Z

ZUCCHINI.....	98-99
---------------	-------

HERBS

ARUGULA (ROCKET).....	85, 113
BALM.....	110
BASIL.....	110-111
BORAGE.....	111
BURNET.....	111
CATNIP.....	111
CHAMOMILE.....	111
CHERVIL.....	111
CHIVES.....	111
COLLECTION.....	111-112
CORIANDER.....	112
CUMIN.....	112
DISCS HERBS.....	9
DILL.....	112
FENNEL.....	112

LAVENDER.....	112
LEMONGRASS.....	112
LOVAGE.....	112
MARJORAM.....	112
MINT.....	113
OREGANO.....	113
PARSLEY.....	113
ROSEMARY.....	113
SAGE.....	114
SAVORY.....	114
SORREL.....	114
STEVIA.....	114
TAGETE.....	114
TARRAGON.....	114
THYME.....	114
WORMWOOD.....	114

NATIVE SEEDS

CLIMBING PLANTS.....	59
GRASSES.....	58
PERENNIALS.....	59-61
SHRUBS.....	56-58
TREES.....	56

TROPICAL PLANTS

ASPARAGUS.....	18
BIRD OF PARADISE.....	20
COFFEA.....	21
LACE TREE PHILODENDRON.....	19
MIMOSA PUDICA.....	21
MONSTERA DELICIOSA.....	19

PARLOR PALM.....	18
SCHEFFLERA.....	18
SILKY OAK.....	21

PRODUCTS AND ACCESSORIES

BOOKS.....	115
CROP PROTECTION.....	126
FEEDERS AND TRAPS.....	127
FERTILIZER AND SOIL AMENDMENTS.....	130
LIGHTING.....	119-122
OUTDOOR ESSENTIALS.....	123-125
PATIO CONTAINERS.....	128-129
SEEDERS.....	116
SEEDLING ESSENTIALS.....	117-118

SPROUTS & MICROGREENS

SEEDS.....	10-12
ACCESSORIES.....	13
COLLECTION.....	13

W.H.PERRON

OR OCCUPANT

customer #



Your hardiness zone is:



W.H.PERRON

2914 Curé-Labelle Blvd, Laval Qc, H7P 5R9

@ mail@whperron.com

800 723-9071 | 450 682-9071

450 682-4959

OBTAIN 10% REBATE
on your purchases at W.H. Perron if your horticultural society is a member of OHA or FSHEQ.



www.fsheq.com



www.gardenontario.com